

the LifeStyle
Barton

Home

Office

Patio

VIENNA DINING TABLE AND CHAIR SET

ITEM # 93501











OWNER'S MANUAL AND SAFETY INSTRUCTIONS

SAVE THIS MANUAL. KEEP THIS MANUAL FOR SAFETY WARNINGS, PRECAUTIONS, ASSEMBLY, OPERATION, INSPECTION, MAINTENANCE AND CLEANING PROCEDURES. WRITE THE PRODUCT'S SERIAL NUMBER ON THE BACK OF THE MANUAL, OR THE MONTH AND YEAR OF PURCHASE IF PRODUCT HAS NO SERIAL NUMBER

FOR QUESTIONS, PLEASE CALL CUSTOMER SERVICE: 909.628.0880

CHAIR ASSEMBLY

| NO. | SKETCH | QTY |
|-----|--|-----|
| A |  | 2 |
| B |  | 2 |
| C |  | 1 |
| D |  | 2 |
| E |  | 16 |
| F |  M6*20MM | 8 |
| G |  M5*9MM | 8 |
| H |  | 1 |

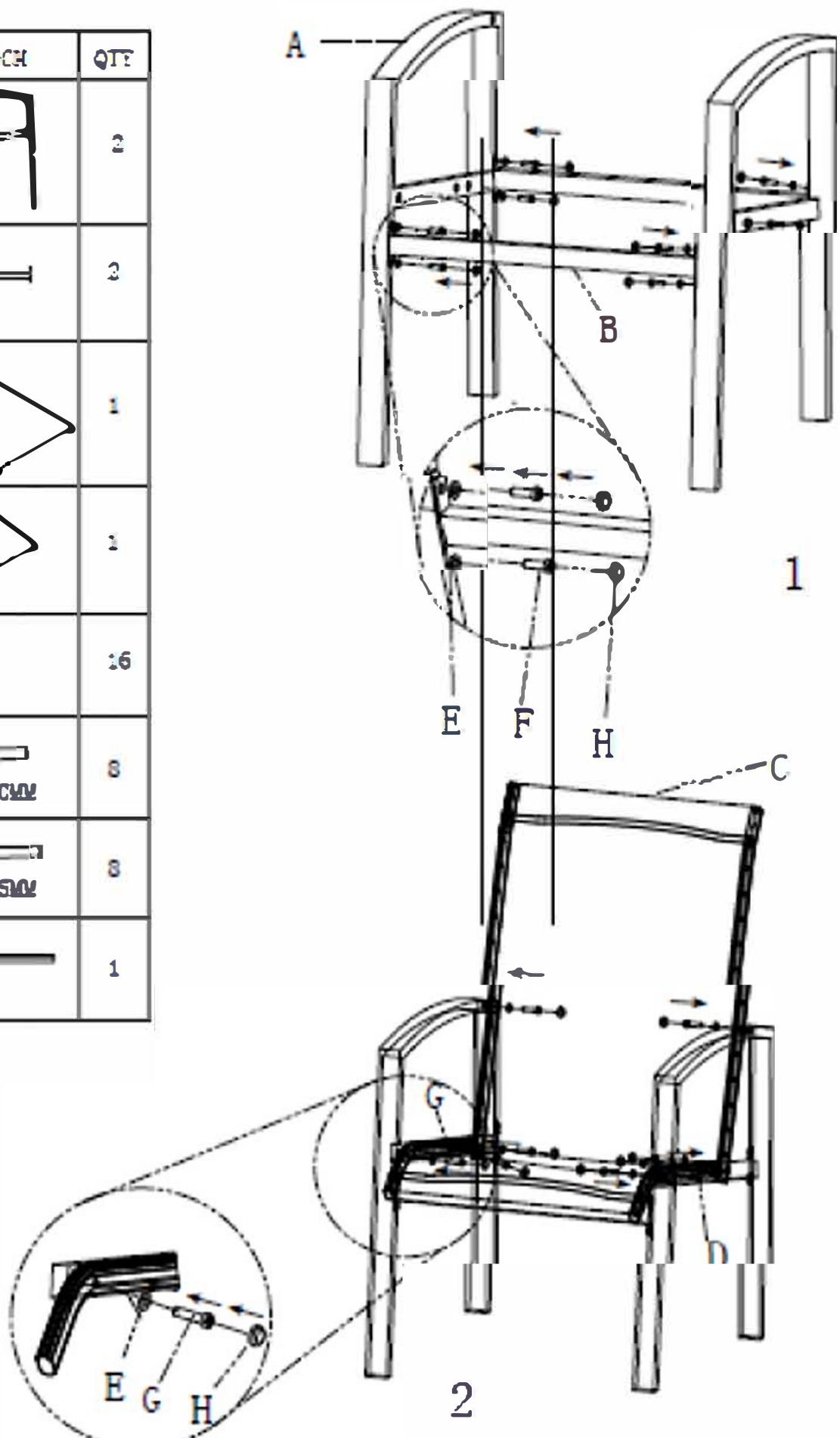









TABLE ASSEMBLY

| NO. | SKETCH | QTY |
|-----|--|-----|
| A |  | 4 |
| B |  | 1 |
| C |  | 1 |
| D |  | 12 |
| E |  M6*25MM | 8 |
| F |  M6*15MM | 4 |
| G |  | 1 |

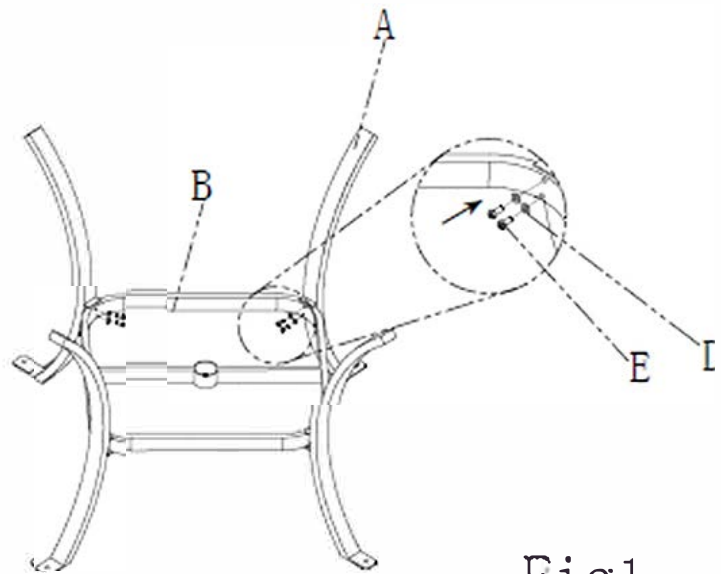

Fig1

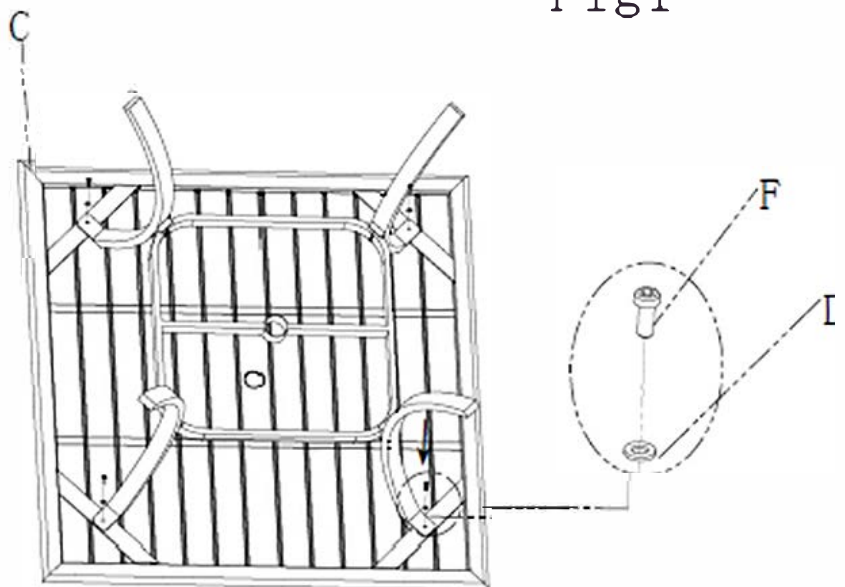

Fig2



Fig3

Thank you for your purchase! Your new Barton patio set and accessories are designed for many years of enjoyment with proper care. Please adopt the following practices to ensure the longevity of your purchase.

General Cleaning

Regular cleaning should be done with a damp, non-colored, non-abrasive cloth soaked in clear water. Use mild soap as necessary. Avoid the use of abrasive cleaners and power washers. Clean spills immediately with a damp, non-colored, non-abrasive cloth and mild soap solution to avoid staining.

To protect the finish of painted metal products from scratches, dulling, and wear and tear, apply a clear coat, such as an epoxy clear coat, at least once per year. If the finish becomes scratched or chipped, move quickly to apply touch up paint to avoid exposure of the underlying metal to the elements. Lightly sand the area to be painted with 600 grit or finer sandpaper. Wipe the area clean. Then, hold the paint can 8-10 inches away from the surface and sweep the area applying a thin coat of paint each pass. Allow the paint to dry between each coat. Alternatively, you may apply paint to a separate surface then use a small brush to touch-up the scratched area. If you are repairing a finish that consists of more than one color, first apply the base coat, then apply the highlight color using a small brush, per the methods described above. You may want to test on a piece of cardboard or other surface before working on the product.

Tubular/cast iron products will eventually rust. More frequent maintenance and application of clear coats, covering the sets when not in use to protect from exposure, and especially prompt attention to scratches or chips will prolong the life of iron sets. However, because of the nature of iron, it will eventually rust when exposed to humidity and/or the elements. Rusting or oxidation is not covered under the Limited Warranty.

Using the product in a coastal environment places higher demand on the surface finish due to the effects of salty/corrosive air. More frequent cleaning (weekly or biweekly) is necessary to remove any buildup of salt residue. Quarterly application of a clear coat is necessary to maintain a strong surface finish in this type of environment.

For all items, avoid exposure, especially prolonged exposure to harsh environments including rain, snow, or other wet conditions, direct sunlight, extremely high or low temperatures, and salty or corrosive air. Products should be covered or brought indoors when not in use, especially when not in use for prolonged periods of time, or when otherwise exposed to harsh weather such as winter. Do not put hot items directly on furniture surface. Always use coasters, placemats, trivets, or hot pads. Do not clean with harsh cleaners or polish. Do not place near heating or cooling vents.

MESH CLEANING

Remove light stains with a solution of mild detergent and water, then rinse with clear water and dry thoroughly. Mildew and heavy stains can be removed with a quality commercial outdoor furniture cleaner and protectant.

DISCLAIMER

PLEASE READ THE FOLLOWING CAREFULLY

THE MANUFACTURER AND/OR DISTRIBUTOR HAS PROVIDED THE PARTS LIST AND ASSEMBLY DIAGRAM IN THIS MANUAL AS A REFERENCE TOOL ONLY. NEITHER THE MANUFACTURER OR DISTRIBUTOR MAKES ANY REPRESENTATION OR WARRANTY OF ANY KIND TO THE BUYER THAT HE OR SHE IS QUALIFIED TO MAKE ANY REPAIRS TO THE PRODUCT, OR THAT HE OR SHE IS QUALIFIED TO REPLACE ANY PARTS OF THE PRODUCT. IN FACT, THE MANUFACTURER AND/OR DISTRIBUTOR EXPRESSLY STATES THAT ALL REPAIRS AND PARTS REPLACEMENTS SHOULD BE UNDERTAKEN BY CERTIFIED AND LICENSED TECHNICIANS, AND NOT BY THE BUYER. THE BUYER ASSUMES ALL RISK AND LIABILITY ARISING OUT OF HIS OR HER REPAIRS TO THE ORIGINAL PRODUCT OR REPLACEMENT PARTS THERETO, OR ARISING OUT OF HIS OR HER INSTALLATION OF REPLACEMENT PARTS THERETO.

Record Product's Serial Number Here: _____

Note: If product has no serial number, record month and year of purchase instead.

Note: Some parts are listed and shown for illustration purposes only and are not available individually as replacement parts.

Questions, issues or missing parts?

Before returning to your retailer, our customer service team is here to help.



Call Us: 909.628.0880

Email Us: customer@bartonliving.com

Hours of Operation: 9am - 3pm PST Monday - Friday

MADE IN CHINA