

the LifeStyle
Barton

Home

Office

Patio

WICKER EGG CHAIR

ITEM # 98106









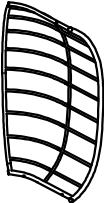
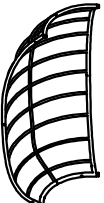
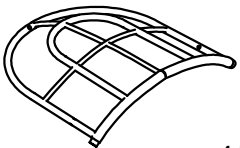
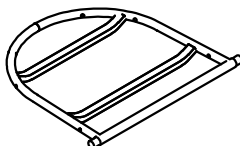
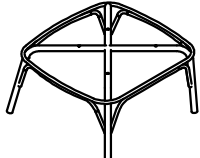
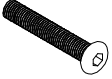

OWNER'S MANUAL AND SAFETY INSTRUCTIONS

SAVE THIS MANUAL. KEEP THIS MANUAL FOR SAFETY WARNINGS, PRECAUTIONS, ASSEMBLY, OPERATION, INSPECTION, MAINTENANCE AND CLEANING PROCEDURES. WRITE THE PRODUCT'S SERIAL NUMBER ON THE BACK OF THE MANUAL, OR THE MONTH AND YEAR OF PURCHASE IF PRODUCT HAS NO SERIAL NUMBER

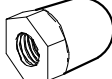
FOR QUESTIONS, PLEASE CALL CUSTOMER SERVICE: 909.628.4900

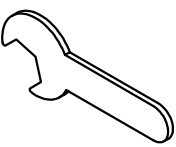
PARTS LIST AND HARDWARE

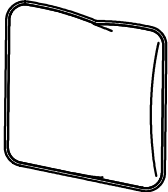
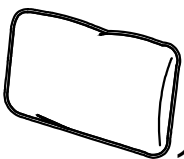
<p>A</p>  <p>1PC</p>	<p>B</p>  <p>1PC</p>	<p>C</p>  <p>1PC</p>	<p>D</p>  <p>1PC</p>
<p>E</p>  <p>1PC</p>	<p>F</p>  <p>1PC</p>	<p>G</p>  <p>M6*35mm 4PCS</p>	<p>H</p>  <p>M6*50mm 12PCS</p>
<p>I</p>  <p>M6*55mm 3PCS</p>	<p>J</p>  <p>19PCS</p>	<p>K</p>  <p>15PCS</p>	<p>L</p>  <p>1PC</p>
<p>M</p>  <p>1PC</p>	<p>N</p>  <p>1PC</p>	<p>O</p>  <p>1PC</p>	<p>P</p>  <p>1PC</p>

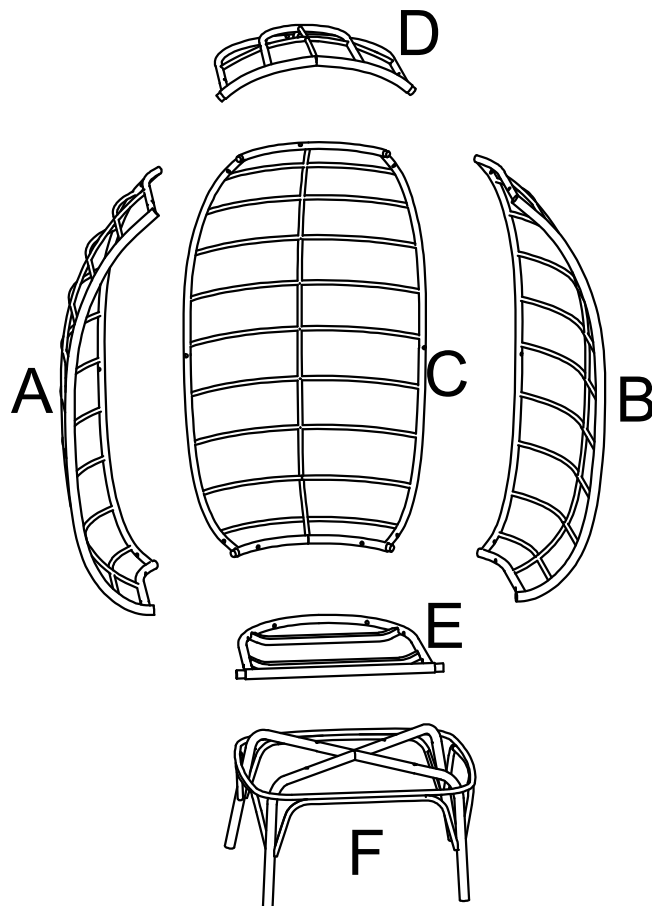

ASSEMBLY

STEP 1

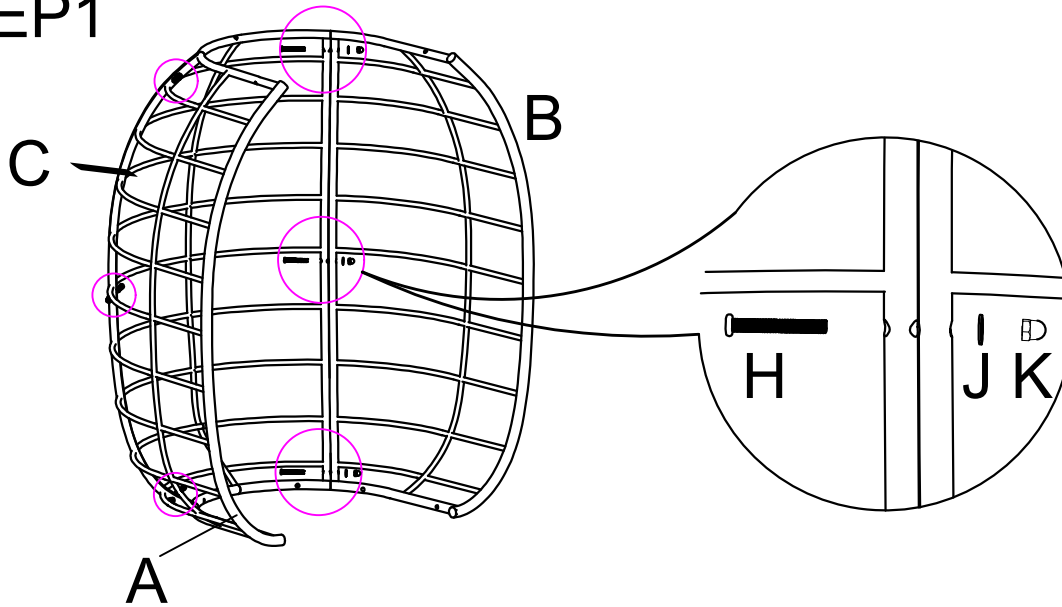

STEP 2

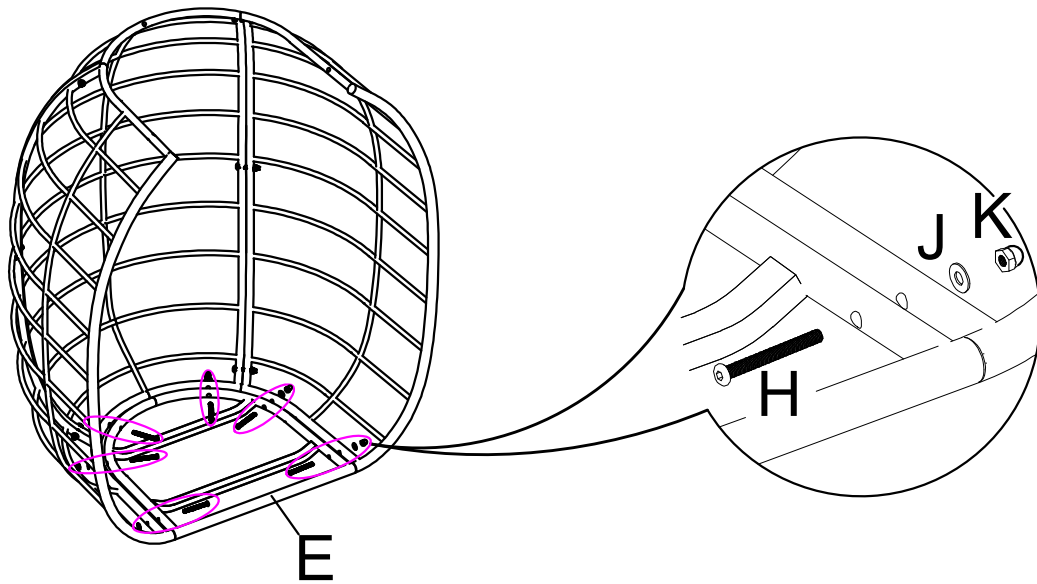

STEP 3

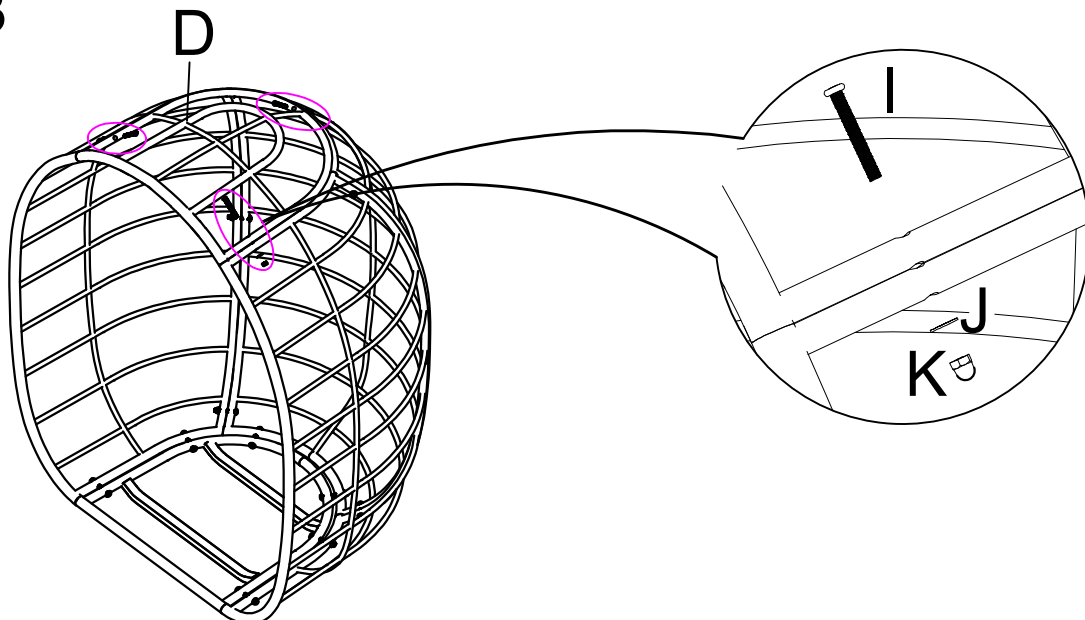

ASSEMBLY

STEP4

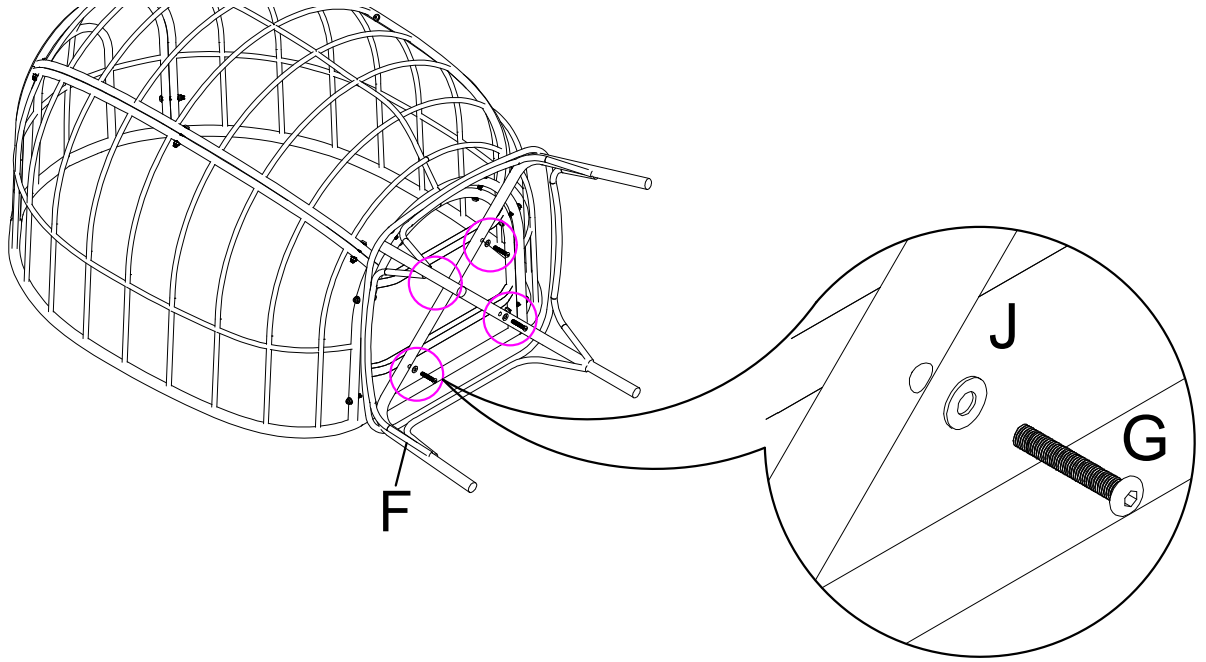

STEP5

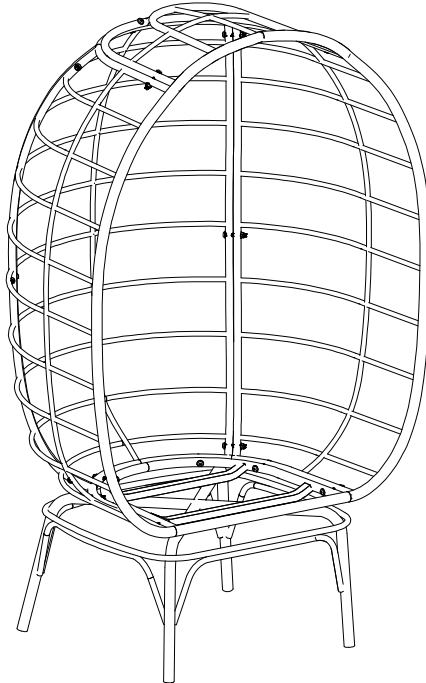

STEP6

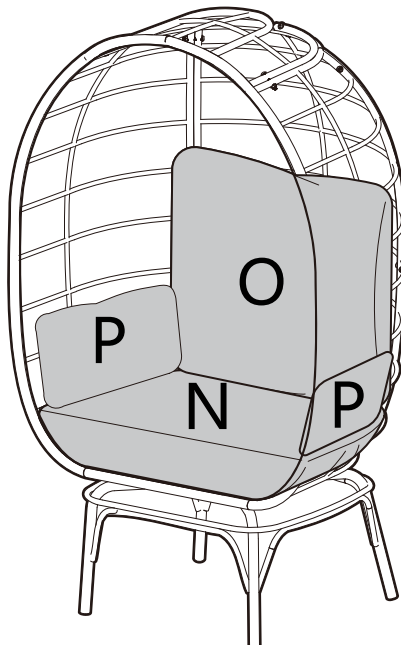

DISCLAIMER

PLEASE READ THE FOLLOWING CAREFULLY

THE MANUFACTURER AND/OR DISTRIBUTOR HAS PROVIDED THE PARTS LIST AND ASSEMBLY DIAGRAM IN THIS MANUAL AS A REFERENCE TOOL ONLY. NEITHER THE MANUFACTURER OR DISTRIBUTOR MAKES ANY REPRESENTATION OR WARRANTY OF ANY KIND TO THE BUYER THAT HE OR SHE IS QUALIFIED TO MAKE ANY REPAIRS TO THE PRODUCT, OR THAT HE OR SHE IS QUALIFIED TO REPLACE ANY PARTS OF THE PRODUCT. IN FACT, THE MANUFACTURER AND/OR DISTRIBUTOR EXPRESSLY STATES THAT ALL REPAIRS AND PARTS REPLACEMENTS SHOULD BE UNDERTAKEN BY CERTIFIED AND LICENSED TECHNICIANS, AND NOT BY THE BUYER. THE BUYER ASSUMES ALL RISK AND LIABILITY ARISING OUT OF HIS OR HER REPAIRS TO THE ORIGINAL PRODUCT OR REPLACEMENT PARTS THERETO, OR ARISING OUT OF HIS OR HER INSTALLATION OF REPLACEMENT PARTS THERETO.

Record Product's Serial Number Here: _____

Note: If product has no serial number, record month and year of purchase instead.

Note: Some parts are listed and shown for illustration purposes only and are not available individually as replacement parts.

The material in this manual is for informational purposes only. The product(s) it describes are subject to change without prior notice, due to the manufacturer's continuous development program. Barton makes no representations or warranties with respect to this manual or with respect to the products described herein. Barton shall not be liable for any damages, losses, costs or expenses, direct, indirect or incidental, consequential or special, arising out of, or related to the use of this material or the products described herein.

QUESTIONS OR MISSING PARTS?

OUR CUSTOMER SERVICE TEAM IS HERE TO HELP



CALL US: 909.628.4900

EMAIL: CUSTOMER@BARTONLIVING.COM

HOURS OF OPERATION: TUESDAY-FRIDAY 9AM-3PM

MADE IN CHINA