

STARK[®]
·U·S·A·
ELITE

1200W DEMOLITION HAMMER

ITEM# 61132



OWNER'S MANUAL AND SAFETY INSTRUCTIONS

SAVE THIS MANUAL. KEEP THIS MANUAL FOR SAFETY WARNINGS, PRECAUTIONS, ASSEMBLY, OPERATION, INSPECTION, MAINTENANCE AND CLEANING PROCEDURES. WRITE THE PRODUCT'S SERIAL NUMBER ON THE BACK OF THE MANUAL, OR THE MONTH AND YEAR OF PURCHASE IF PRODUCT HAS NO SERIAL NUMBER

FOR QUESTIONS, PLEASE CALL CUSTOMER SERVICE: 909.628.4900

Application

This hammer should be applied to breaking concrete, chipping off concrete, grooving, bar cutting, and driving piles in installation of piping and wiring, unitary facility installation, machinery installation water supply, and drainage work, interior jobs, harbor facilities and other civil engineering involved.

Contents

1. Machine information
2. Optional accessories
3. Safety instruction
4. Assembly
5. Operation
6. Maintenance and inspection

1. Machine information

Technical Data

Model number	61132
Rated Voltage	AC 110V
Frequency	60Hz
Rated current	10A
No load speed	3100/min
Tool holder	17mm HEX
Chisel positioning	6 Step
Weight (without cord)	13.22lbs
Impact energy	11J
Protection class	II

Standard accessories

One box of grease	30g (one box)
Bull point chisel(17x280mm)	1 piece
flat chisel(17x280mm)	1 piece
Carbon brush(6*10*14mm)	2 pieces

2. Optional accessories (sold separately)

Notice: Optional accessories (sold separately) are recommended only for tool for specified purpose in manual, any other brand accessories or attachments used may present risk of injury.

1. Point chisel Hexagon size17*280 length (Unit:mm)



2. Flat chisel Hexagon size17*280 length (Unit:mm)



3. Bigflat chisel Hexagon size17*280 length*50Cutting width (Unit:mm)



4. Tine spade Hexagon size17*500 length (Unit:mm)



5. Groove chisel Hexagon size17*280 length (Unit:mm)



6. 4PCS KITS Hexagon size17*280 length (Unit:mm)









7. Lubricate grease one box 30g



Optional accessories are subject to change without notice.

3. Safety instructions

In this operator's manual/or machine labels following symbols are used:

	Class II tool		Read the operating instructions before use.
	General Warning		Warning: Electricity
	Wear ear , eye and dust mask protection.		Immediately unplug the plug from the main electricity in the case that the cord gets damage and during maintenance.

SAFETY WARNINGS

⚠ WARNING Read all safety warnings and all instructions. *Failure to follow the warnings and instructions may result in electric shock, fire and/or serious injury.*

Save all warnings and instructions for future reference.

The term "power tool" in the warnings refers to your mains-operated (corded) power tool or battery-operated (cordless) power tool.

1) Work area safety

- a) **Keep work area clean and well lit.** *Cluttered or dark areas invite accidents.*
- b) **Do not operate power tools in explosive atmospheres, such as in the presence of flammable liquids, gases or dust.** *Power tools create sparks which may ignite the dust or fumes.*
- c) **Keep children and bystanders away while operating a power tool.** *Distractions can cause you to lose control.*

2) Electrical safety

- a) **Power tool plugs must match the outlet. Never modify the plug in any way. Do not use any adapter plugs with earthed (grounded) power tools.** *Unmodified plugs and matching outlets will reduce risk of electric shock.*
- b) **Avoid body contact with earthed or grounded surfaces such as pipes, radiators, ranges and refrigerators.** *There is an increased risk of electric shock if your body is earthed or grounded.*
- c) **Do not expose power tools to rain or wet conditions.** *Water entering a power tool will increase the risk of electric shock.*
- d) **Do not abuse the cord. Never use the cord for carrying, pulling or unplugging the power tool. Keep cord away from heat, oil, sharp edges or moving parts.** *Damaged or entangled cords increase the risk of electric shock.*
- e) **When operating a power tool outdoors, use an extension cord suitable for outdoor use.** *Use of a cord suitable for outdoor use reduces the risk of electric shock.*
- f) **If operating a power tool in a damp location is unavoidable, use a residual current device (RCD) protected supply.** *Use of an RCD reduces the risk of electric shock.*

3) Personal safety

- a) **Stay alert, watch what you are doing and use common sense when operating a power tool. Do not use a power tool while you are tired or under the influence of drugs, alcohol or medication.** *A moment of inattention while operating power tools may result in serious personal injury.*
- b) **Use personal protective equipment. Always wear eye protection.** *Protective equipment such as dust mask, non-skid safety shoes, hard hat, or hearing protection used for appropriate conditions will reduce personal injuries.*
- c) **Prevent unintentional starting. Ensure the switch is in the off-position before connecting to power source and/or battery pack, picking up or carrying the tool.** *Carrying power tools with your finger on the switch or energising power tools that have the switch on invites accidents.*
- d) **Remove any adjusting key or wrench before turning the power tool on.** *A wrench or a key left attached to a rotating part of the power tool may result in personal injury.*
- e) **Do not overreach. Keep proper footing and balance at all times.** *This enables better control of the power tool in unexpected situations.*

SAFETY WARNINGS

- f) **Dress properly. Do not wear loose clothing or jewellery. Keep your hair, clothing and gloves away from moving parts.** *Loose clothes, jewellery or long hair can be caught in moving parts.*
 - g) **If devices are provided for the connection of dust extraction and collection facilities, ensure these are connected and properly used.** *Use of dust collection can reduce dust-related hazards.*
- 4) **Power tool use and care**
- a) **Do not force the power tool. Use the correct power tool for your application.** *The correct power tool will do the job better and safer at the rate for which it was designed.*
 - b) **Do not use the power tool if the switch does not turn it on and off.** *Any power tool that cannot be controlled with the switch is dangerous and must be repaired.*
 - c) **Disconnect the plug from the powersource and/or the battery pack from the power tool before making any adjustments, changing accessories, or storing power tools.** *Such preventive safety measures reduce the risk of starting the power tool accidentally.*
 - d) **Store idle power tools out of the reach of children and do not allow persons unfamiliar with the power tool or these instructions to operate the power tool.** *Power tools are dangerous in the hands of untrained users.*
 - e) **Maintain power tools. Check for misalignment or binding of moving parts, breakage of parts and any other condition that may affect the power tool's operation. If damaged, have the power tool repaired before use.** *Many accidents are caused by poorly maintained power tools.*
 - f) **Keep cutting tools sharp and clean.** *Properly maintained cutting tools with sharp cutting edges are less likely to bind and are easier to control.*
 - g) **Use the power tool, accessories and tool bits etc. in accordance with these instructions, taking into account the working conditions and the work to be performed.** *Use of the power tool for operations different from those intended could result in a hazardous situation.*
- 5) **Service**
- a) **Have your power tool serviced by a qualified repair person using only identical replacement parts.** *This will ensure that the safety of the power tool is maintained.*

Additional Safety Rules for Demolition Hammer

1. **Wear ear protectors.** *Exposure to noise can cause hearing loss.*
2. **Use auxiliary handles, if supplied with the tool.** *Loss of control can cause personal injury.*
3. **Hold power tools by insulated gripping surfaces, when performing an operation where the cutting tool may contact hidden wiring or its own cord.** *Cutting accessory contacting a "live" wire may make exposed metal parts of the power tool "live" and could give the operator an electric shock.*
4. **Wear a dust mask.** *Do not inhale the harmful dusts generated in drilling or chiseling operation. The dust can endanger the health of yourself and bystanders.*
5. Be sure the bit is secured in place before operation.
6. Under normal operation, the machine is designed to produce vibration, the screws and bolts can come loose, causing a breakdown and accidents. Check tightness of them carefully before running.
7. In cold weather or a long time tool not be used, please keep the tool running without load a few minutes to warm up the grease inside, otherwise hammering function is difficult to get.
8. Be sure you stand stably and no one is below when you using tool is in high location.
9. Hold the tool firmly with two hands.
10. Don't touch any moving parts.

SAFETY WARNINGS

11. Don't leave the tool running itself, operate tool only when hand-held.
12. Don't point the tool to anybody for the bit could fly out in case.
13. Don't touch the BIT OR PARTS CLOSE TO THE BIT immediately after operation, they may extremely hot and could burn your skin.
14. Any damage and abnormal happen, please stop to use immediately and disconnect it, ask authorized serve center to check and repair.
15. **Parts replace:** Only original Stark parts can be used to replace by authorized service center.
16. **Right use accessories and parts:** Don't use other parts and accessories which not mentioned in the manual otherwise may cause injuries!
17. **Special attention to voltage:** Before connect the power tool, please make sure the rated voltage on the tool can match the power supply, otherwise the power tool may be damaged and cause injuries.
18. **Don't wipe plastic part with solvent:** Solvent such as gasoline, thinner, alcohol etc. These kind of chemical material, are not allowed to use, water or soap are recommended!
19. In case of damages the replacement of the plug or the supply cord shall always be carried out by the manufacturer of the tool or his service organization
20. If the replacement of the supply cord is necessary, this has to be done by the manufacturer or his agent in order to avoid a safety hazard.

Residual risks

Even when the power tool is used as prescribed it is not possible to eliminate all residual risk factors. The following hazards may arise in connection with the power tool's construction and design:

1. Damage to lungs if an effective dust mask is not worn.
2. Damage to hearing if effective hearing protection is not worn.
3. Damages to health resulting from vibration emission if the power tool is being used over longer period of time or not adequately managed and properly maintained.

WARNING! This power tool produces an electromagnetic field during operation. This field may under some circumstances interfere with active or passive medical implants. To reduce the risk of serious or fatal injury, we recommend persons with medical implants to consult their physician and the medical implant manufacturer before operating this machine.

4. Assembly

Name of the parts

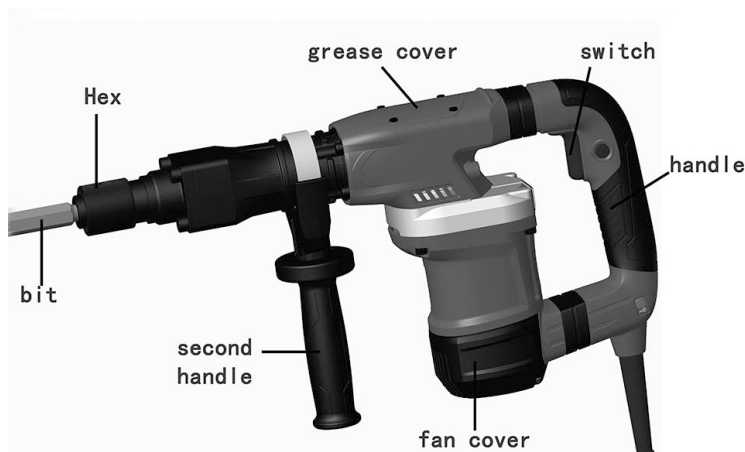

Prior to operation

 Read the ENTIRE IMPORTANT SAFETY INFORMATION section at the beginning of this manual including all text under subheadings therein before set up use of this products.

1. Power source

Ensure that the power source to be utilized conforms to the power requirements which specified on the name plate of the hammer.

2. Power switch

Ensure that the power switch is in the position of OFF. If the plug is connected to power receptacle while the power switch is in ON position, the demolition hammer will start operation immediately, which can cause serious accident!

3. Extension cord

When the work area is removed from the power source, use an extension cord of sufficient thickness and rated capacity. The extension cord should be kept as short as practicable.

Operation

1. Switch action

Switch on	Press the switch towards ① direction
Switch off	Release the switch towards ② direction
If continuous Operation, turn on the switch and then push in The lock button, to stop from the locked Position , just press the Switch fully, then Release it.	

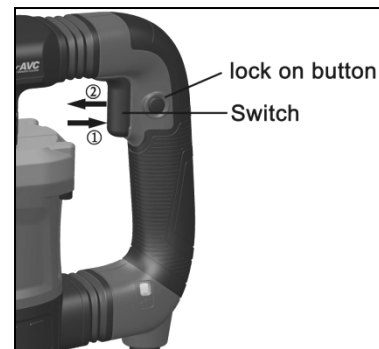

2. Operate this demolition hammer by utilizing extra pressure.

The performance will be better if it is pressed properly against the work surface.

Note:

Sometimes the power tool does not begin the striking the stroke even the motor keep running, because oil inside become thick. If the power tool is used at a low temperature, or it is used after a long idle time, this demolition hammer should be kept running for above 5 minutes to warm up.

Mounting tool bits

Warning: before do it, make sure unplug the machine!



(1) Pivot the Flex Sheath to the side.
(it's difficult to move the retainer with your thumbs, tap it with a hammer.)
insert the bit into the tool barrel as far as it is, then return Flex Sheath to its original position.

(2) To unload tool, according to the direction of arrow mark drop-down telescopic set, remove picks.

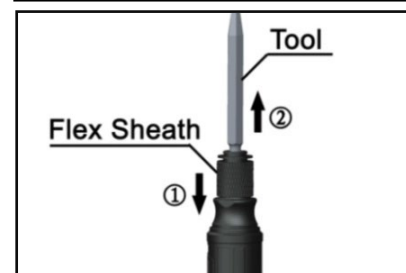
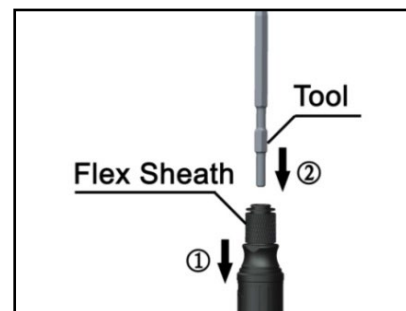

How to replace grease

This machine is of full air-tight construction to protect against dust and to prevent lubricant leakage. Therefore, the machine can be used without lubrication for long periods. Replace the grease as described below.



CAUTION:

Before replenishing the grease, turn the power off and pull out the power plug.

Loosen the four set screws and remove oil tank cover. Wipe off the grease inside.

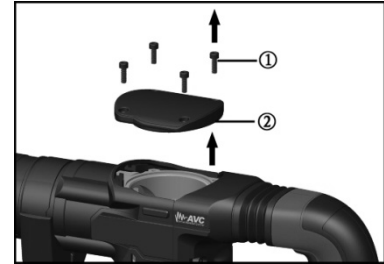

Supply 30g of Demolition Hammer Grease (Standard accessory, contained in tube) to the Crank Housing. Too more or too little will cause the machine non-properly work.

After replenishing the grease, Install the oil tank cover Securely.

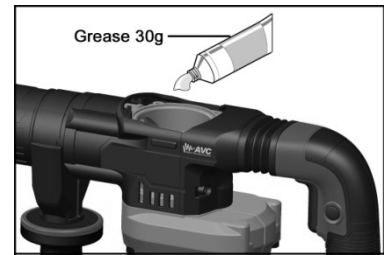

4. Clean the machine.

6. Maintenance and inspection



Before do any maintenance and inspection, ensure unplug the plug.

1. Inspecting the tool

Use a dull accessory, such as bull point, cutter, etc., will cause motor malfunction and efficiency degraded. Replace with a new one when your accessory is abased.

2. Inspecting the mounting screws

Regularly inspect all mounting screws and ensure that they are properly tightened. Any loose should be tighten immediately, failure to do maybe cause serious hazard.

3. Maintenance the motor

The motor is the heart of the machine, please avoid any damage to the winding, or any water and oil to wet it.

4. Carbon brush replacements

4.1 Carbon brushes are consumable parts, when it becomes worn or "limit worn" it can cause motor trouble, we use auto-stop carbon brush, it stopped automatically when carbon brush worn out, at that time, replace a new couple of them as following procedure:

4.2 When you have to replacement the carbon brushes by yourself, please following the order:

(1) Loosen the three set screws and remove fan cover.

(2) Remove the helical spring and carbon brushes.

(3) After replacing the carbon brushes, install the helical spring and fan cover, with securely tightening four set screws.

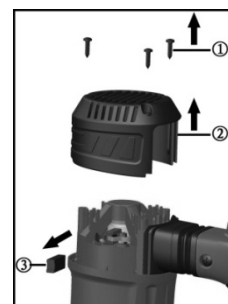

5. Cleaning

Clean the machine regularly with a soft cloth, preferably after each use. Solvent such as gasoline, thinner, alcohol etc. These kind of chemical materials are not allowed to use, water or soap are recommended!

6. Protecting the Environment



Do not dispose of power tools together with household waste material!

The machine, accessories and packaging should be sorted for environmental friendly recycling.

Inobservance of European Directive on waste electrical and electronic equipment and its implementation in accordance with national law, electric tools that have reached the end of their life must be collected separately and returned to an environmentally compatible recycling facility.

CAUTION:

Repair, modification and inspection of Power tools must be carried out by a Authorized Service Center.

In the operation and maintenance of power tools, the safety regulations and standards prescribed in each country must be observed.

MODIFICATIONS:

Power Tools are constantly being improved and modified to incorporate the latest technological advancements.

Accordingly, some parts (i.e. code numbers and/or design) may be changed without prior notice.

PARTS INFORMATION

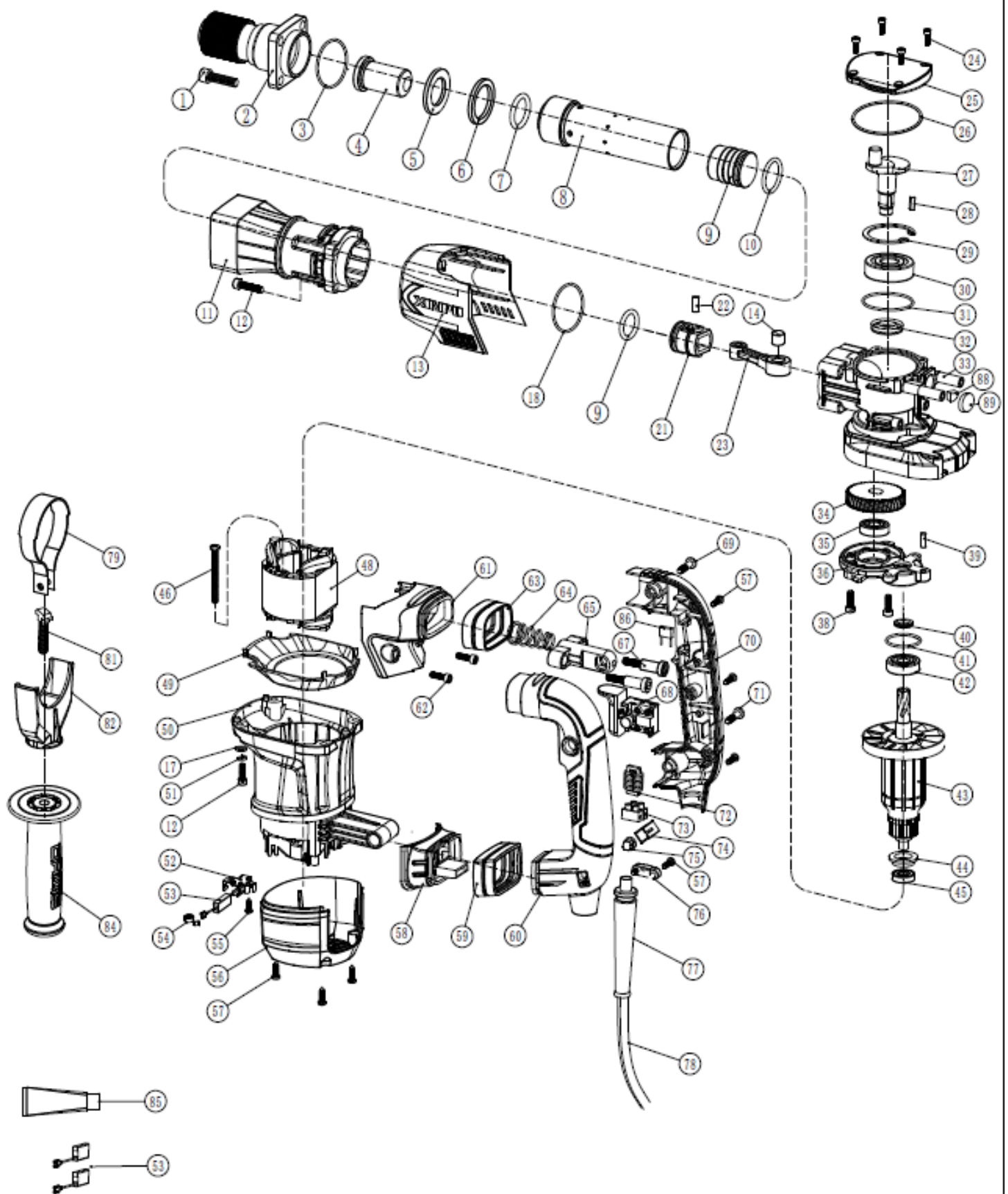

PARTS INFORMATION

Item No.	Part Describe	Quantity	Item No.	Part Describe	Quantity
1	Hex . Socket Bolt M8x30(12.9)	4	46	ST4.8x6.5x30Tapping Screw	2
2	Front Cover Assembly	1	48	Stator 220-240V	1
3	O Ringφ44x2.2	1	48	Stator 110-120V	1
4	Impact Hammer	1	49	Fan Guide	1
5	locking Ring	1	50	Housing Ass'y	1
6	Vibration Reducing Cushion	1	51	φ6 Spring Washer	4
7	Fluorin O Ringφ26.3x4.3	2	52	Carbon brush wire	2
8	Cylinder	1	53	Carbon Brush 220-240V	2
9	Impact Piston	1	53	Carbon Brush 110-120V	2
10	Fluorin O Ringφ28.4x3.5	2	54	Coil spring	2
11	Outside Cover Of Cylinder	1	55	ST 3.5x12 Cross recessed pan head tapping screws	4
12	Hex . Socket Bolt M6x25(12.9)	8	56	Fan Cover	1
13	Cover	1	57	ST 4.2x18 Torx head Tapping Screw	8
14	Needle Bearingφ12xφ19x12	1	58	Bottom Support Seat	1
17	φ6xφ10.5 Flat Washer	4	59	Bottom Shock Absorption Jacket	1
18	O Ringφ31.5xφ1.5	1	60	Main Handle	1
21	Gas Press Piston	1	61	Top Support Seat	1
22	Piston Pin φ8x34	1	62	Hex . Socket Bolt M5x12	2
23	Connecting Rod Ass'y	1	63	Top Shock Absorption Jacket	1
24	Hex . Socket Bolt M4x12	4	64	Shock Absorption Spring	1
25	Oil Tank Cover	1	65	Shock Absorption nog	1
26	O Ringφ55xφ2.5	1	67	M6 Blot	2
27	Crank Shaft	1	68	Switch	1
28	4x12 Palt Key	1	69	ST 5.5x25 Torx head Tapping Screw	1
29	φ47 Retaining Ring	1	70	Main Handle Cover	1
30	6303 RS Ball Bearing	1	71	ST5.5x38 Torxhead Tapping Screw	1
31	O Ringφ46.5xφ2	1	72	Electricity Feels	1
32	Oil Seal Ring φ17xφ30x6	1	73	Rivet	2
33	Decelerate Box	1	74	Indicator Subassembly	1
34	Gear	1	75	Indicator	1
35	6001 RS Ball Bearing	1	76	Cord Clip	1
36	Inner Cover	1	77	Cord Armor	1
38	Hex . Socket Bolt M5x16	4	78	Cord	1
39	φ5x14 Pin	1	79	Side Handle Ass'y Steel Tie	1
40	Whorl Seal Ring	1	81	T-Bolt M8x45	1
41	O Ringφ31.5xφ2	1	82	Side Handle Ass'y Base	1
42	6201 RS Ball Bearing	1	84	Side Handle Ass'y	1
43	Armature 220-240V	1	85	Oil Bottle	1
43	Armature 110-120V	1	86	Electric Capacity	1
44	Armature Insulation Washer	1	88	Woolen Washerφ7.2x7	1
45	608LBV CW Ball Bearing	1	89	Wool block 1	1

DISCLAIMER

PLEASE READ THE FOLLOWING CAREFULLY

THE MANUFACTURER AND/OR DISTRIBUTOR HAS PROVIDED THE PARTS LIST AND ASSEMBLY DIAGRAM IN THIS MANUAL AS A REFERENCE TOOL ONLY. NEITHER THE MANUFACTURER OR DISTRIBUTOR MAKES ANY REPRESENTATION OR WARRANTY OF ANY KIND TO THE BUYER THAT HE OR SHE IS QUALIFIED TO MAKE ANY REPAIRS TO THE PRODUCT, OR THAT HE OR SHE IS QUALIFIED TO REPLACE ANY PARTS OF THE PRODUCT. IN FACT, THE MANUFACTURER AND/OR DISTRIBUTOR EXPRESSLY STATES THAT ALL REPAIRS AND PARTS REPLACEMENTS SHOULD BE UNDERTAKEN BY CERTIFIED AND LICENSED TECHNICIANS, AND NOT BY THE BUYER. THE BUYER ASSUMES ALL RISK AND LIABILITY ARISING OUT OF HIS OR HER REPAIRS TO THE ORIGINAL PRODUCT OR REPLACEMENT PARTS THERETO, OR ARISING OUT OF HIS OR HER INSTALLATION OF REPLACEMENT PARTS THERETO.

Record Product's Serial Number Here: _____

Note: If product has no serial number, record month and year of purchase instead.

Note: Some parts are listed and shown for illustration purposes only and are not available individually as replacement parts.

The material in this manual is for informational purposes only. The product(s) it describes are subject to change without prior notice, due to the manufacturer's continuous development program. XtremePowerUS makes no representations or warranties with respect to this manual or with respect to the products described herein. XtremePowerUS shall not be liable for any damages, losses, costs or expenses, direct, indirect or incidental, consequential or special, arising out of, or related to the use of this material or the products described herein.

Questions, issues or missing parts?

Before returning to your retailer, our customer service team is here to help.



Call Us: 909.628.4900

Email Us: info@starktoolsusa.com

Hours of Operation: 9am - 3pm PST Monday - Friday

MADE IN CHINA