



## 55CC POST HOLE DIGGER+B" ICE BIT AUGER

ITEM: 81092



### OWNER'S MANUAL AND SAFETY INSTRUCTIONS

SAVE THIS MANUAL: KEEP THIS MANUAL FOR SAFETY WARNINGS, PRECAUTIONS, ASSEMBLY, OPERATING, INSPECTION, MAINTENANCE AND CLEANING PROCEDURES. WRITE THE PRODUCT'S SERIAL NUMBER ON THE BACK OF THE MANUAL NEAR THE ASSEMBLY DIAGRAM (OR MONTH AND YEAR OF PURCHASE IF PRODUCT HAS NO NUMBER)

FOR QUESTIONS PLEASE CALL OUR CUSTOMER SUPPORT: (909) 628 0880 MON-FRI 9AM TO 3PM PST

# IMPORTANT SAFETY INFORMATION

## GENERAL SAFETY WARNINGS

**Read all safety warnings and instructions. Failure to follow the warnings and instructions may result in electric shock, fire and/or serious injury. Save all warnings and instructions for future reference.**

The warnings, precautions, and instructions discussed in this instruction manual cannot cover all possible conditions and situations that may occur. It must be understood by the operator that common sense and caution are factors which cannot be built into this product, but must be supplied by the operator. Read carefully and understand all ASSEMBLY AND OPERATION INSTRUCTIONS before operating. Failure to follow the safety rules and other basic safety precautions may result in serious personal injury.

- **Read and understand all instructions.** Failure to follow all instructions may result in serious injury or property damage.
- **DO NOT** allow persons to operate or assemble the product until they have read this manual and have developed a thorough understanding of how it works.
- **DO NOT modify this product in any way.** Unauthorized modification may impair the function and/or safety and could affect the life of the product. There are specific applications for which the product was designed.
- **Use the right tool for the job. DO NOT** attempt to force small equipment to do the work of larger industrial equipment. There are certain applications for which this equipment was designed. This product will be safer and do a better job at the capacity for which it was intended. **DO NOT** use this equipment for a purpose for which it was not intended.
- **Keep children and bystanders away from the work area while operating the tool. DO NOT** allow children to handle the product.
- **Buried utility lines may be unmarked;** contact utility companies before drilling. Contacting utility lines may cause severe personal injury or death.
- **Check for landscape fabric before drilling.** Landscape fabric may get pulled into the Bit and also pull the operator into the Bit. Before drilling, cut a hole in the landscape fabric sufficiently larger than the diameter of the Auger to prevent contact or entanglement with the fabric.
- **Keep everyone other than the operator at least 10 feet from the Auger during operation.** People using hand tools should not move or remove soil-pile while the Auger is operating. Always keep children away from the Auger, especially while it is operating.
- To prevent severe personal injury or dismemberment from rotating Bit: Stand on flat, level, solid surface and brace against torque during use. Keep hands and feet away from Bit and hole when Engine is running.
- **DO NOT** lock trigger on. Never disable safety switches or components.
- Maintain a firm grip on the Auger with both hands and be aware of the strong start-up torque of the tool.
- Disconnect and insulate spark plug wire before maintenance and/or changing bits.
- **DO NOT** carry between holes with Engine running.
- **Carry by handle only; not by Bit.** Keep your thumb near the power Switch in the event the Auger must be turned off immediately.

# IMPORTANT SAFETY INFORMATION

- **DO NOT** use the Auger if the Bit is dull, bent, or damaged.
- **Drill with the Engine running at full speed.** Fully squeeze the Throttle to maintain a steady drilling speed.
- When shutting off the Engine, make sure the Auger has stopped before setting the tool down.
- **Fire Hazard! DO NOT** fill fuel tank while engine is running. **DO NOT** operate if gasoline has been spilled. Clean spilled gasoline before starting engine. **DO NOT** operate near pilot light or open flame.
- **DO NOT** touch engine during use. Let engine cool down after use.
- Never store fuel or other flammable materials near the engine.
- Only use a suitable means of transport and lifting devices with sufficient weight bearing capacity when transporting the Auger. Secure the Auger on transport vehicles to prevent it from rolling, slipping, and tilting.
- Industrial applications must follow OSHA requirements.
- **DO NOT** leave the Auger unattended when it is running. Turn off the Auger (and remove safety keys, if available) before leaving the work area.
- The Auger can produce high noise levels. Prolonged exposure to noise levels above 85 dBA is hazardous to hearing. Wear ear protection when operating the Auger or when working nearby while it is operating.
- Wear ANSI-approved safety glasses, hearing protection, and NIOSH-approved dust mask/ respirator under a full-face shield along with steel-toed work boots during use.
- People with pacemakers should consult their physician(s) before use. Electromagnetic fields in close proximity to a heart pacemaker could cause pacemaker interference or pacemaker failure. Caution is necessary when near the engine's magneto or recoil starter.
- Use this Auger with both hands only. Using Auger with only one hand can easily result in loss of control.
- Dress properly. **DO NOT** wear loose clothing or jewelry. Keep hair, clothing and gloves away from moving parts. Loose clothes, jewelry or long hair can be caught in moving parts.
- **DO NOT** smoke, or allow sparks, flames, or other sources of ignition around the Auger, especially when refueling.
- When spills of fuel or oil occur, they must be cleaned up immediately. Dispose of fluids and cleaning materials as per any local, state, or federal codes and regulations. Store oil rags in a bottom-ventilated, covered, metal container.
- Before use, check for misalignment or binding of moving parts, breakage of parts, and any other condition that may affect the Auger's operation. If damaged, have the Auger serviced before using.
- Anyone using vibrating tools regularly or for an extended period should first be examined by a doctor and then have regular medical check-ups to ensure medical problems are not being caused or worsened from use. Pregnant women or people who have impaired blood circulation to the hand, past hand injuries, nervous system disorders, diabetes, or Raynaud's Disease should not use this tool. If you feel any symptoms related to vibration (such as tingling, numbness, and white or blue fingers), seek medical advice as soon as possible.
- To reduce vibration, maintain the tool as explained in this manual. If any abnormal vibration occurs, stop use immediately.
- Before service, maintenance, or cleaning: Turn the engine switch to its "OFF" position. Allow the engine to completely cool. Then, remove the spark plug cap from the spark plug.

# IMPORTANT SAFETY INFORMATION

**IMPORTANT! A.** You do not operate the Auger Drill with the proper 25:1 fuel mix in the fuel tank. **DO NOT** run the engine with an improper fuel mix, low or no fuel mix. Running the engine with an improper fuel mix, low or no fuel mix, can permanently damage the unit. **B.** You fail to operate the Auger Drill with the proper amount of SAE 80-90 gear oil in its Gearbox. **DO NOT** run the Auger Drill with low, or no gear oil. Running the Auger Drill with low or no gear oil can permanently damage the unit. **C.** Maintain labels and nameplates on the Auger Drill. These carry important information. **D.** Always wear safety equipment. When operating the Auger Drill, wear **ANSI** approved safety impact eye goggles, hearing protection, heavy duty work gloves, sturdy steel-toe boots and head protection.

## CARBON MONOXIDE PRECAUTIONS

**This Auger Drill is designed for outdoor use only. DO NOT** operate this drill in indoor, closed or poorly ventilated areas. When running, the engine of this product produces carbon monoxide, a colorless and odorless toxic gas that, when inhaled, can cause serious personal injury or death.

## FIRE AND EXPLOSION PRECAUTIONS

**Gasoline fuel and fumes are flammable and potentially explosive.** Use proper fuel storage and handling procedures. Have multiple ABC class fire extinguishers nearby when using this power tool. Keep the Auger Drill and surrounding areas clean and dust free at all times.

1. If oil or fuel spills occur, they must be cleaned up immediately. Dispose of fluids and cleaning materials as per any local state or federal codes and regulations. Store oil rags in a covered metal container.
2. **DO NOT** store fuel or other flammables near the Auger Drill.
3. **DO NOT** smoke or allow sparks, flames or other sources of ignition around the Auger Drill.
4. Keep grounded conductive objects such as tools away from exposed, live electrical parts and connections to avoid sparking or arcing. Failure to do so could ignite fumes or vapors.
5. **DO NOT** refill the fuel tank while the engine is running or while the engine is still hot. **DO NOT** operate the Auger Drill with any known leaks on the fuel system.
6. Use only manufacturer recommended fuel and oil.
7. Prior to performing service, maintenance or cleaning procedures, allow the engine to completely cool. Then, remove the spark plug from the engine.
8. **DO NOT** alter or adjust any part of the Auger Drill or engine that is assembled and supplied by the manufacturer.
9. Follow scheduled Auger drill engine maintenance.

## CHEMICAL PRECAUTIONS

1. **Avoid contact with hot fuel, oil and exhaust fumes.**
2. **Avoid body contact with fuels, oils and lubricants used in the Auger Drill and engine. If swallowed, seek medical attention immediately. DO NOT** induce vomiting if fuel is swallowed. For skin contact, immediately wash with soap and water. If fuel gets in the eyes, immediately flush eyes with clean water.

**WARNING:** This product contains or, when used, produces a chemical known to the state of California to cause cancer and birth defects or other reproductive harm. (California Health and Safety Codes 25249.5, et seq.)

**NOTE:** This item does not meet California CARB requirements and is not for sale or use in California.

# ASSEMBLY AND OPERATION

## ASSEMBLY

Insert the shank of the Auger (33a) fully upward into the Transmission Shaft (15a). Align the mounting holes in the Auger and Transmission Shaft. Then secure the Auger to the Auger Drill using the Pin (34a) and Safety Pin (35a).

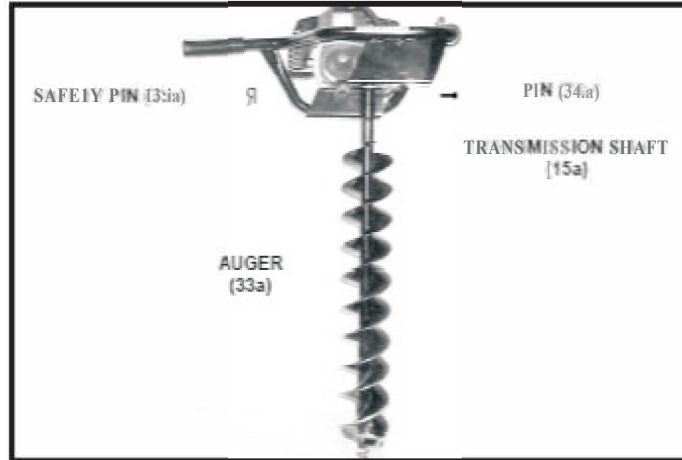

## PRE-START INSTRUCTIONS

1. Fill the fuel tank: To obtain the proper 25:1 fuel mix, combine 25 parts unleaded gasoline (89+ octane) with 1 part 2-cycle oil in the provide Fuel Mix Container (36a). Cover and shake to thoroughly mix before each fueling.

**NOTE:** Mix only enough fuel for a few days work. The maximum storage time of mixed fuel is three months.

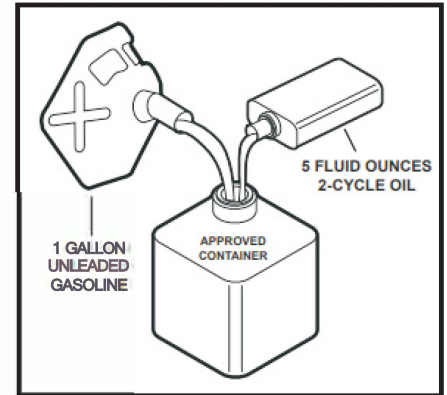

2. Once the proper fuel mix is obtained, removed the Fuel Cap (93). Fill the Fuel Tank (89) approximately  $\frac{3}{4}$  full with the fuel mix. Then replace the Fuel Cap. See Figure B.

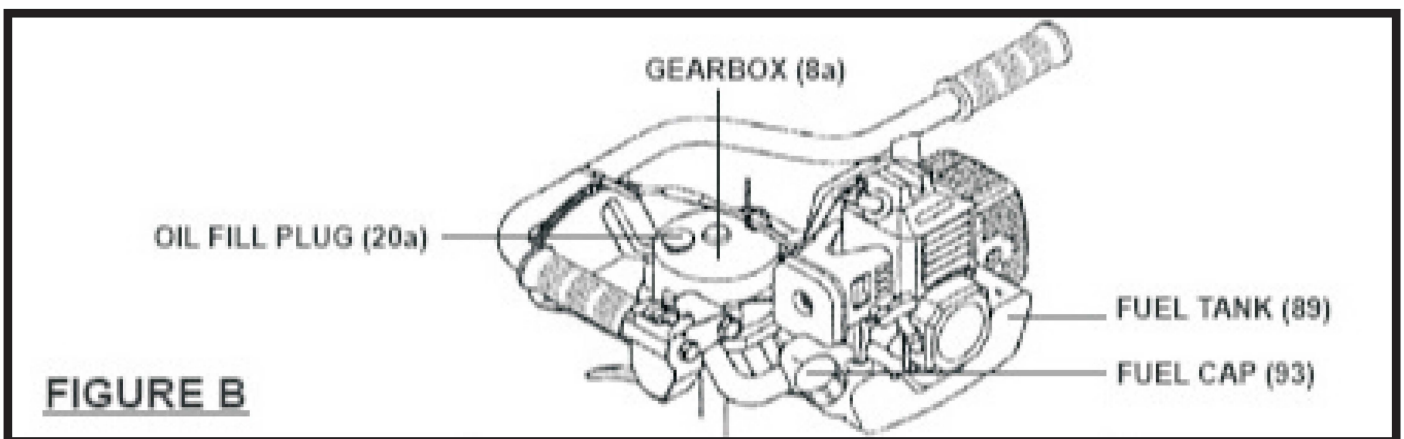

**WARNING:** Do not attempt to fill the Fuel Tank (89) when the engine is running or hot to the touch.

# OPERATION

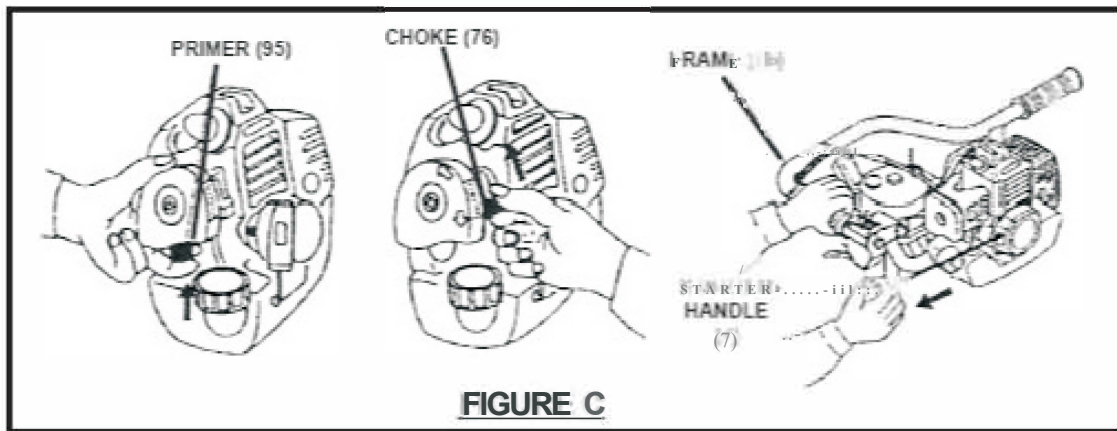

## STARTING AND STOPPING THE AUGER DRILL

1. Place the Auger Drill on its side with the Auger (33a) resting upon the ground surface location that is to be drilled. Make sure no debris, clothing or other objects are near the Auger Bit. Keep all bystanders a safe distance away.
2. Depress the Primer (95) three to four times. See figure C.
3. Set the Choke (76) to the appropriate position: Closed if the engine is cold. Open if the engine is warm. See Figure C.
4. Grip the Frame (1 b) firmly with your left hand. Keep all body parts away from the bit. Then, with your right hand. Pull rapidly on the Starter Handle (7) to start the engine. See Figure C.
5. Once the engine is started, set the Choke (76) to its open position.
6. If the engine does not start, press the Primer (95) again. Set the Choke (76) to its closed position and again attempt to start the engine. See Figure C.
7. Once the engine is started, set the choke to its open position.
8. If the engine does not start press the Primer (95) again. Set the choke to its closed position and again attempt to start the engine. See Figure C.

**NOTE:** If the engine is new or has been stored for a long period of time, pull the Starter Handle (7) several times to ensure sufficient fuel is delivered into the fuel line and combustion chamber of the engine. See Figure C.

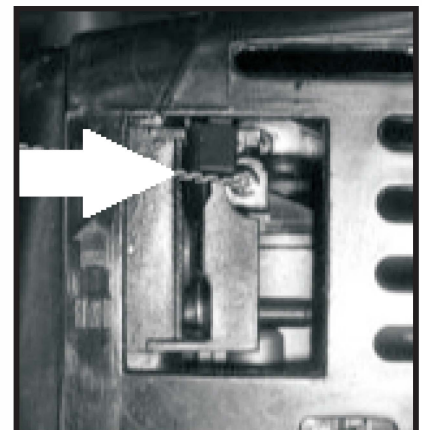
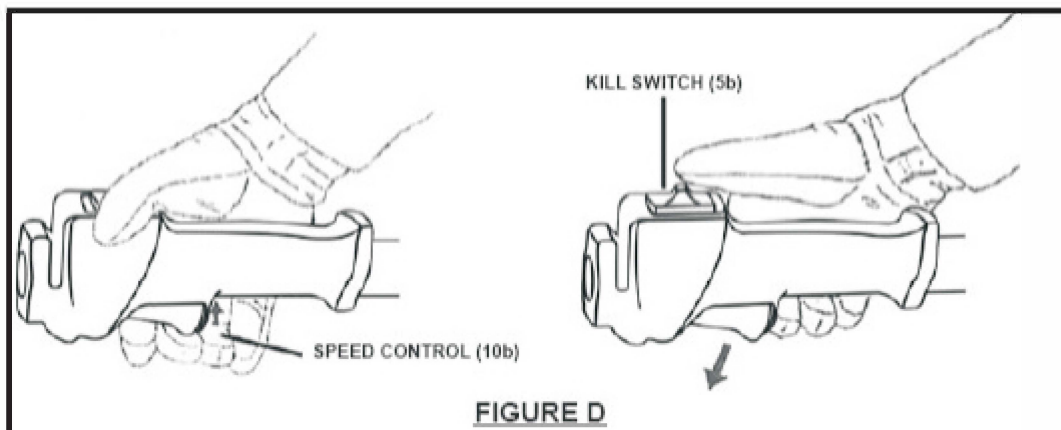

9. As soon as the engine is running, check to make sure the Choke (76) is in its open position. Squeeze the Speed Control (10b) briefly and let up. The Speed Control will revert to its original position, causing the engine to idle. See Figure C and D
10. To stop the Auger Drill, release pressure on the Speed Control (10b). Then press down on the Kill Switch (5b). Keep your thumb near the Kill Switch in the event the Auger Drill must be stopped immediately. See Figure D.

# OPERATION

## DRILLING A HOLE

1. Stand with a solid stance on stable ground. Brace yourself and maintain a proper grip with both hands on the Frame (1 b) whenever the engine is running. See Figure E
2. Accelerate the engine to full throttle just before starting to drill by squeezing the Speed Control (1 Ob) Also, keep the engine at full throttle the entire time you are drilling, unless a problem arises.
3. Do not attempt to drill at an angle. Always Keep the Auger vertical .
4. Allow the Auger to do most of the work. Exert only minimal pressure downwards. Attempting to force the drill can cause permanent damage to the unit. Be cautious that the drill will have strong twisting force during operation.
5. Release the Speed Control as soon as drilling is complete, let the engine idle. Running the Auger Drill at full throttle without a drilling load can cause unnecessary wear or damage to the unit.
6. After running the drill for an extended period, allow the engine to idle for several minutes to allow heat to dissipate. This will prevent system parts like the ignition, piston rings, carburetor etc. from being damaged by overheating. Once you have done this press the Kill Switch (5b) to turn off the engine. See Figure E
7. Before storing the Auger Drill, make sure to drain all fuel from the fuel tank (89). Failure to do so may cause old fuel left in the tank to clog the carburetor and prevent start up until it is cleaned out. Once you have emptied the fuel tank, store the Auger Drill in a clean, dry, safe location. Keep out of reach of children. See Figure E

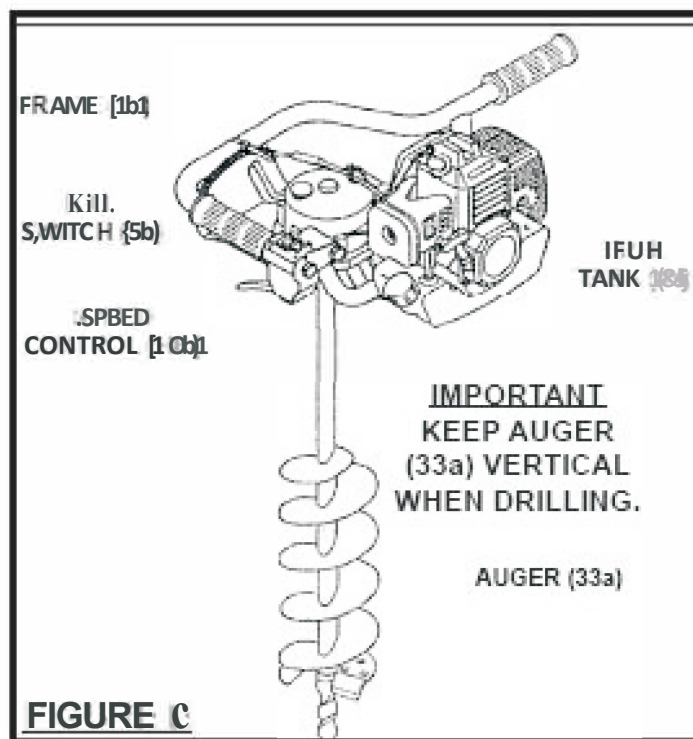

## INSPECTION, MAINTENANCE AND CLEANING

1. **WARNING:** Remove the Spark Plug (51) and allow the engine to cool completely prior to performing any service, maintenance or cleaning of the Auger Drill.
2. **Before Each Use:** Inspect the general condition of the Auger Drill. Check for misalignments or binding of moving parts, cracked or broken parts, dull or damage parts or any other condition that may affect the safe operation of the unit. If abnormal noise or vibration occurs, have the problem inspected by a professional before further use. Do not use the unit if damaged.

# ASSEMBLY

3. Auger Drill (33a) Maintenance: Using the Auger while that is bent or filled with excessive debris can cause serious injury. Be sure to replace a defective Auger and always keep the unit clean.
4. Spark Plug (51) Maintenance: The condition of the Spark Plug should be checked ever six months or every 100 hours of total use. If necessary, clean or replace the Spark Plug. The recommended Spark Plug replacement type is: L7T
5. Air Filter (78) Maintenance: The Air Filter should be checked prior to each use of the Auger Drill for debris and buildup. The Air Filter should be replaced every 3 months or 50 hours of tool use.
6. Gearbox (Sa) Maintenance: The Gearbox should be checked prior to each use for proper quantity. If necessary, fill the Gearbox with SAE 80-90 weight gear oil. The Gearbox should be filled with clean Gear oil every 3 months or after 50 hours of tool use.
7. To Clean the Auger Drill: Use a clean cloth and mild detergent to clean the exterior of the engine. **DO NOT** use Solvents. Rinse off with caution, **DO NOT** introduce liquids into the interior of the engine.

**CAUTION:** All maintenance, service or repairs not mentioned in this manual must only be performed by a qualified service technician.



**Many maintenance procedures, including any not detailed in this manual, will need to be performed by a qualified technician for safety. If you have any doubts about your ability to safely service the Auger or engine, have a qualified technician service the Auger instead.**

## QUICK START GUIDE

1. Insert the shank of the Bit fully upward into the Transmission Socket on the bottom of the Auger. Secure the Bit in the Transmission Socket, using the Pin and R-Pin.
2. Place the Auger on its side with its Bit resting on the ground that is to be drilled. Press the Primer three or four times.
3. Set the Choke, START if the Engine is cold. RUN if the Engine is warm.
4. Move the Power Switch to the I position. Squeeze and release the Throttle.
5. Grip the Frame firmly with your left hand. Keep all body parts well away from the Bit. Then, with your right hand, grip the Starter Handle of the Engine gently until resistance is felt. Allow Cable to retract fully and then pull it quickly. Repeat until the engine starts.
6. Once the Engine is started, press the Choke down slowly to open it. If the Engine does not start, press the Primer one more time. Raise the Choke if it is pressed down, and again attempt to start the Engine.
7. Accelerate the Engine to full throttle just before starting to drill by squeezing the Throttle. Keep the Engine at full throttle the entire time you are drilling, unless a problem arises.
8. During drilling, periodically pull Auger up to remove loosened earth. If loosened earth is allowed to remain in the drilled hole, the Auger will screw into the earth, become stuck, and twist violently.



**For more information on assembling this product, scan the QR Code to watch the instructional video.**



# TROUBLESHOOTING

PROBLEM	POSSIBLE CAUSES	PROBABLE SOLUTIONS
<b>ENGINE WILL NOT START</b>	No fuel in in tank or fuel valve closed.	Fill fuel tank with proper 25:1 unleaded gasoline/ 2-cycle oil mix
	Choke is not in START position, cold engine.	Move Choke to START position.
	Not enough fuel getting to the carburetor.	Press primer 3-4 times. Set choke to START then start the engine
	Faulty Spark Plug	Clean or replace the spark plug
	Contaminated or low quality fuel mixture	Empty old fuel from tank and replace with fresh fuel mixture.
	insufficient electrical getting to spark plug	Have a certified technician inspect the electrical system
	Dirty fuel passageways	Clean out passageways using fuel additive. Heavy deposits may require further cleaning.
	Too much fuel in chamber. Can be caused by the carburetor needle sticking.	Turn Choke to RUN position. Remove spark plug pull the start handle several times to air out the chamber. Reinstall spark plug and set Choke to START to position.
<b>ENGINE RUNS - AUGER NOT ROTATING</b>	Speed control not being properly used	Make sure to fully squeeze the speed control
	Speed control cable improperly adjusted	Have a qualified technician reset the speed control cable
	Auger stuck in rocks, roots etc.	Remove the Auger from the hole and clear the hole of obstructions
<b>GEARBOX HOT TO THE TOUCH</b>	Low level of gear oil.	Immediately turn off Auger. Allow gearbox to completely cool. discontinue using Auger until the gearbox is repaired by a qualified service technician. Immediately
<b>POWER SWITCH DOESN'T TURN OFF THE ENGINE</b>	Faulty Power switch.	remove spark plug cap from spark plug to stop Engine. Discontinue using Auger until the tool is repaired by a qualified service technician.

# PARTS DIAGRAM

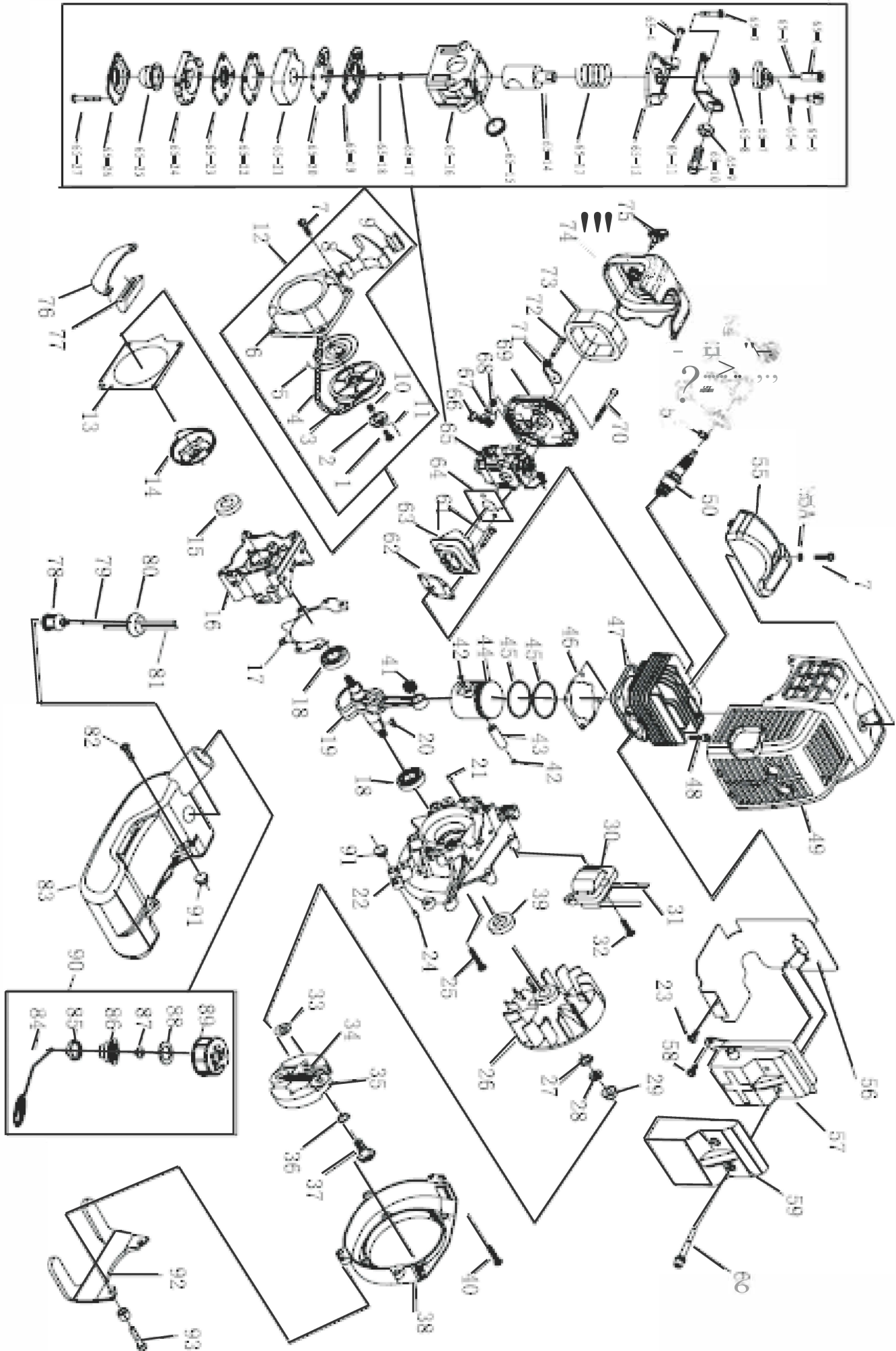

# PARTS LIST

	QTY	#	DESCRIPTION	QTY	#	DESCRIPTION	QTY	#	DESCRIPTION	QTY	#	DESCRIPTION
1	1	25	Screw M5x30	4	48	Screw M5x2.0	4	71	Choker	1		1
2	1	26	Magneto Rotor Comp	1	49	Guide Cover Assy	1	72	Screw ST4 2x12	1		1
3	1	27	Washer B	1	50	Spark Plug	1	73	Filter Net	1		1
4	1	28	Washer B	1	51	Spring	1	74	Cleaner Olltside Cover	1		1
5	1	29	NutM8	1	52	Plug cap	1	75	Screw	1		1
6	1	30	Ignition Coil Comp	1	53	Cap	1	76	Stand	1		1
7	5	31	Cord Comp	1	54	Plug	1	77	Rubber Gover	1		1
8	1	32	Bolt M5x20	2	55	Cover	1	78	Cleaner Gover	1		1
9	1	33	Washer B	2	56	Gasket	1	79	Fuel Pipe	1		1
10	1	34	Spring	1	57	Milffler	1	80	Plug	1		1
11	2	35	Expander	2	58	ScrewM5x12	2	81	Fuel Pipe	1		1
12	1	36	Washer	2	59	Cover	1	82	Screw M5x16	2		2
13	1	37	Screw Pin	2	60	ScrewM6x55	2	83	Fuel Tank	1		1
14	1	38	Fan Cover	1	61	Screw M5x 25	2	84	Chain	1		1
15	1	39	Oil Seal	1	62	Gasket	1	85	End Cover	1		1
16	1	40	Screw M5x25	2	63	Admitting Pipe	1	86	Inside Cover	1		1
17	1	41	Bearing	1	64	Gasket	1	87	Inlet	1		1
18	2	42	Ring	2	65	Carburetor	1	88	Gasket	1		1
19	1	43	Piston	1	66	Choker Handle	1	89	Fuel Tank Lid	1		1
20	1	44	Piston Pin	1	67	Stop Ring	1	90	lid Assy	1		1
21	2	45	Piston Ring	2	68	NutM4	1	91	Rubber Washer	2		2
22	1	46	Gasket	1	69	Cleaner Inside Co,ver	1	92	Stand	1		1
23	1	47	Cylinder	1	70	ScrewM5x50	2	93	Screw M5x30	2		2
24	2		Pin B4x10									

## PLEASE READ THE FOLLOWING CAREFULLY

THE MANUFACTURER AND/OR DISTRIBUTOR HAS PROVIDED THE PARTS LIST AND ASSEMBLY DIAGRAM IN THIS MANUAL AS A REFERENCE TOOL ONLY NEITHER THE MANUFACTURER OR DISTRIBUTOR MAKES ANY REPRESENTATION OR WARRANTY OF ANY KIND TO THE BUYER THAT HE OR SHE IS QUALIFIED TO MAKE ANY REPAIRS TO THE PRODUCT, OR THAT HE OR SHE IS QUALIFIED TO REPLACE ANY PARTS OF THE PRODUCT. IN FACT, THE MANUFACTURER AND/OR DISTRIBUTOR EXPRESSLY STATES THAT ALL REPAIRS AND PARTS REPLACEMENTS SHOULD BE UNDERTAKEN BY CERTIFIED AND LICENSED TECHNICIANS, AND NOT BY THE BUYER. THE BUYER ASSUMES ALL RISK AND LIABILITY ARISING OUT OF HIS OR HER REPAIRS TO THE ORIGINAL PRODUCT OR REPLACEMENT PARTS THERETO, OR ARISING OUT OF HIS OR HER INSTALLATION OF REPLACEMENT PARTS THERETO.

Record Product's Serial Number Here: \_\_\_\_\_

Note: If product has no serial number, record month and year of purchase instead.

Note: Some parts are listed and shown for illustration purposes only and are not available individually as replacement parts.



**SAVE THESE INSTRUCTIONS.**

## Questions, problems, missing parts?



Before returning to your retailer, our exceptional customer service is here to help.

**Call Us: 909.628.0880**

**Email Us: [c.u:1tomer@Xtremepowerusa.com](mailto:c.u:1tomer@Xtremepowerusa.com)**

**Hours of Operation: 9am -4pm (Monday- Friday)**

**PRODUCT MADE IN CHINA**