

Barton

Living

**ROCKING CHAIR
WITH CUSHION**

**ITEM: 98110
98111**



**ASSEMBLY
AND USER'S GUIDE**

98110 

98111 

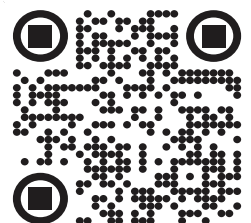

TABLE OF CONTENTS

TABLE OF CONTENTS	1
IMPORTANT SAFETY INSTRUCTIONS	2
<i>Legends and Symbols</i>	2
GENERAL SAFETY	3
CHILD SAFETY	4
OVERVIEW (PRODUCT INFORMATION)	5
FRONT VIEW	5
REAR VIEW	5
PACKAGING CONTENTS	6
PRODUCT DIMENSIONS	7
SPECIFICATION	7
ASSEMBLY	8
CHAIR ASSEMBLY	8
CUSHION ASSEMBLY	12
COMPLETED	13
DISCLAIMER	14
<i>Disclaimer</i>	14
<i>Customer Service and Technical Support</i>	14

IMPORTANT SAFETY INSTRUCTIONS





IMPORTANT SAFETY INSTRUCTIONS

This guide provides instructions for assembling and using the furniture. If you have any questions about the product, please contact Barton.

This guide contains important information about safely assembling and using this product. After assembling, make sure to share this information with the owner/user or leave it with them for their reference.

Legends and Symbols

When you come across the safety-alert symbol on your product or in this manual, pay attention to the following signal words and remain vigilant about the potential for personal injury.

-  **DANGER:** Ignoring these hazards can result in death, severe personal injury, or significant property damage.
-  **WARNING:** Indicates potential hazards that can result in severe personal injury, death, or significant property damage. Ignoring these warnings presents a real danger.
-  **CAUTION:** Indicates potential hazards that can result in minor or moderate personal injury, property damage, or actions that are unpredictable and unsafe. Ignoring these cautions presents a potential hazard.
-  **NOTE:** This label indicates important special instructions that are not directly related to hazards.

USE OF NON-BARTON REPLACEMENT PARTS VOIDS WARRANTY

ATTENTION INSTALLER: This manual contains crucial information regarding the assembly and safe use of this furniture piece. It is essential to provide this manual to the end user of the product. Failure to read and follow all instructions could lead to potential damage or injury.

 Failure to comply with all instructions and warnings may lead to severe bodily injury or damage. This furniture must be assembled and positioned exclusively by someone familiar with proper assembly techniques. Before using this furniture, assemblers and users must carefully review these warnings and all instructions provided in the user's guide. It is essential to leave these warnings and the user's guide with the furniture owner for their reference and safety.

IMPORTANT SAFETY INSTRUCTIONS

GENERAL SAFETY

WARNING

- Review safety instructions carefully to avoid damage or injury. Keep this manual for reference.
- **Maximum Load:** To ensure safety and longevity for the Rocking Chair, follow the manufacturer's weight guidelines.
- **Usage Guidelines:** Intended for seated use only; refrain from standing or jumping on the chair .
- **Setup:** In case of self-assembly, closely follow the manufacturer's guidelines and ensure its sturdiness periodically.
- **Assembly Area:** Set up the Rocking Chair on even ground, ensuring a safe distance from potential risks.
- **Cushion Safety:** Confirm cushions or pads on the Rocking Chair are firmly attached to stop them from becoming dislodged.
- **Hazard Distance:** Place the Rocking Chair at a safe distance from grills, open flames, or other possible dangers.
- **Regular Maintenance:** Periodically inspect the Rocking Chair for wear, damage, or loose components, ensuring to secure any parts that may be coming undone. Make it a routine to thoroughly examine for any signs of deterioration or rattan unraveling.
- **Sharp Object Advisory:** Make certain the vicinity of the Rocking Chair is devoid of sharp objects that could harm the rattan.
- **Cleaning Advisory:** Opt for cleaning products specifically designed for rattan to prevent unintentional harm or discoloration.
- **Safekeeping:** In times of prolonged inactivity or during the off-season, keep in a cool, dry place.
- **Cover Usage:** Think about using protective covers when not in use to enhance the product's longevity.
- **Adverse Weather Advice:** Should bad weather occur, think about relocating the Rocking Chair to shielded spots for protection.
- **Water Accumulation Notice:** After weather events or cleaning, ensure the seating areas remain free from accumulated water to mitigate slipping risks.
- **Sun Exposure Warning:** Extensive sunlight can degrade the rattan's integrity. Utilize protective sheaths or position in shaded spots when inactive.

IMPORTANT SAFETY INSTRUCTIONS

CHILD SAFETY

DANGER

- **Supervision Required:** Always supervise children when they are near or using the Rocking Chair.
- **Climbing Warning:** Avoid letting children ascend the Rocking Chair to prevent potential falls or tipping incidents.
- **Finger Safety:** Keep an eye on children to prevent them from inserting fingers or limbs into rattan openings.
- **Seating Guidance:** Direct children to sit steadily in the chair, preventing sudden movements that might cause the chair to tilt or fall.
- **Water Accumulation Notice:** After weather events or cleaning, ensure the seating areas remain free from accumulated water to mitigate slipping risks.
- **Cushion Safety:** Confirm cushions or pads on both the Rocking Chair are firmly attached to stop them from becoming dislodged.

OVERVIEW (PRODUCT INFORMATION)

OVERVIEW (PRODUCT INFORMATION)

FRONT VIEW



REAR VIEW

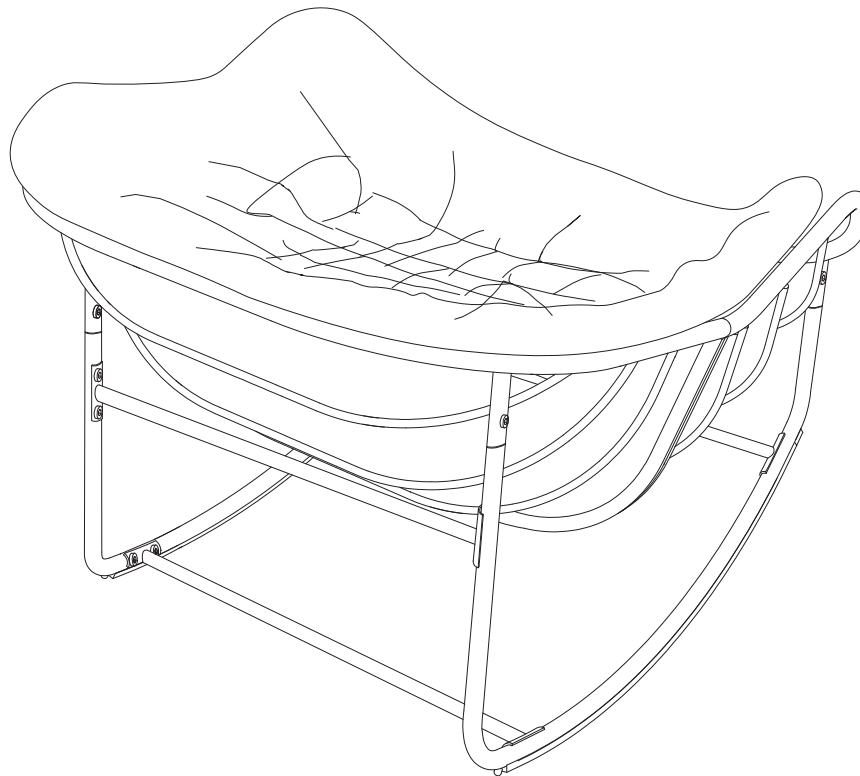

OVERVIEW (PRODUCT INFORMATION)

PACKAGE CONTENTS

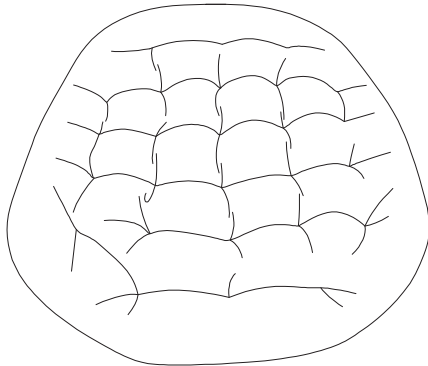

PART#: F
1 PC(S)

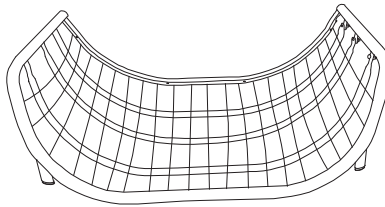

PART#: A
1 PC(S)

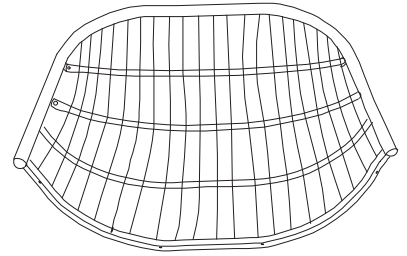

PART#: B
1 PC(S)



PART#: C
1 PC(S)



PART#: D
1 PC(S)

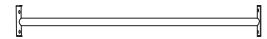

PART#: E
3 PC(S)



M6 X 15
PART#: L1
12 PC(S)



M6 X 35
PART#: L2
4 PC(S)



M6 X 45
PART#: L3
4 PC(S)

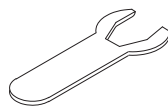

PART#: G
1 PC(S)



PART#: H
1 PC(S)

OVERVIEW (PRODUCT INFORMATION)

PRODUCT DIMENSIONS

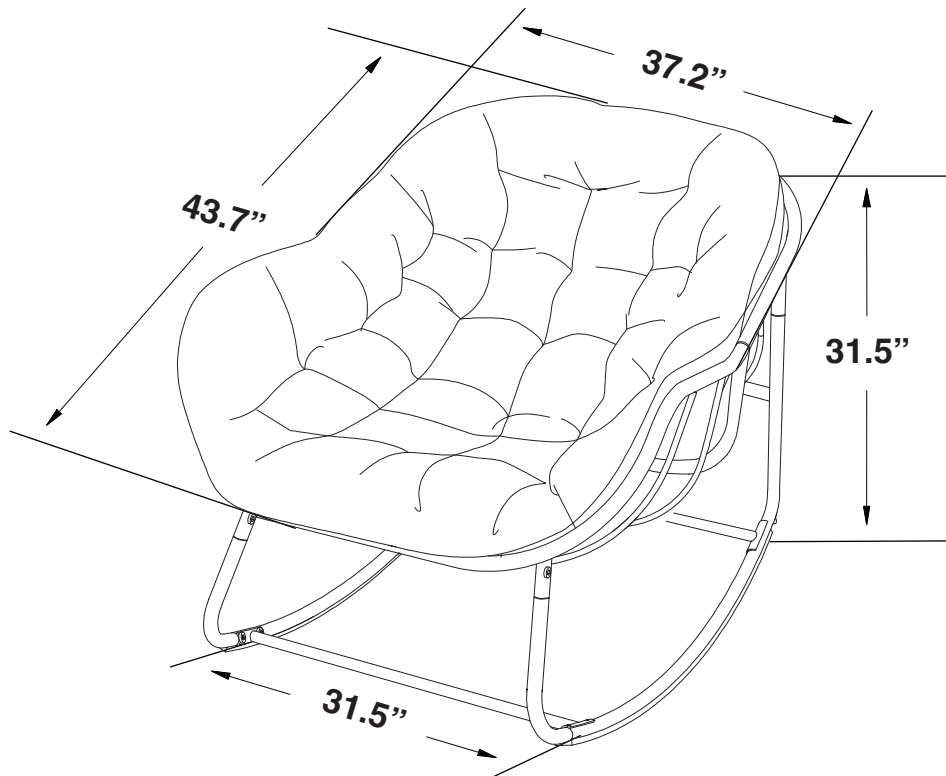

SPECIFICATIONS

Model	98110	98111
Color	Beige	Grey
Material:		
Frame	Steel	Steel
Surface	PE Rattan	PE Rattan
Fabric	Polyester	Polyester
Product Weight	40 LBS	40 LBS
Dimensions	37.2" x 43.7" x 31.5"	37.2" x 43.7" x 31.5"

ASSEMBLY

ASSEMBLY

CHAIR ASSEMBLY

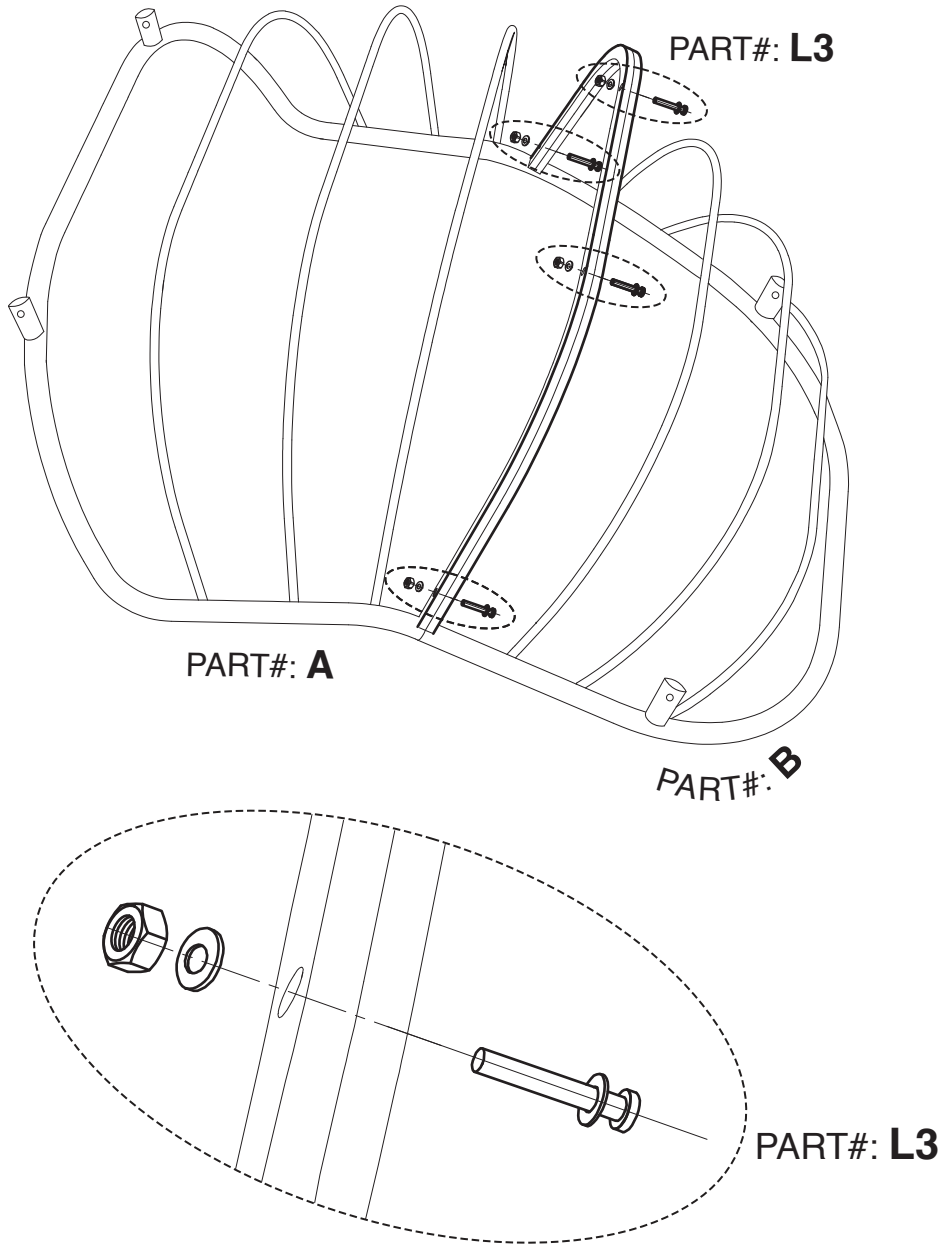

ASSEMBLY

CHAIR ASSEMBLY (CONTINUED)

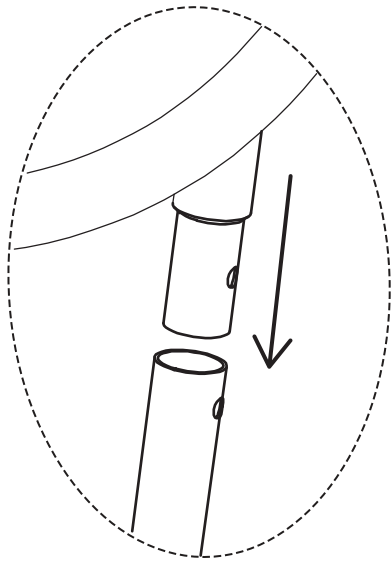
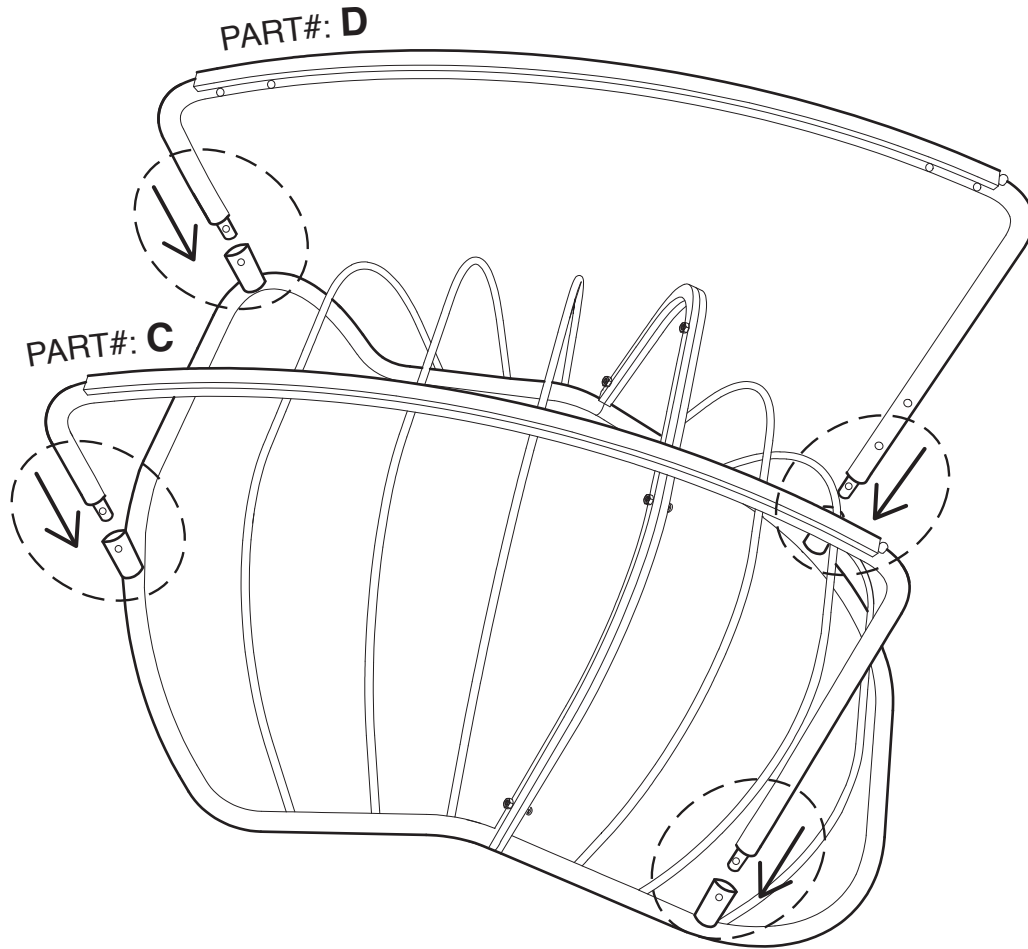

ASSEMBLY

CHAIR ASSEMBLY (CONTINUED)

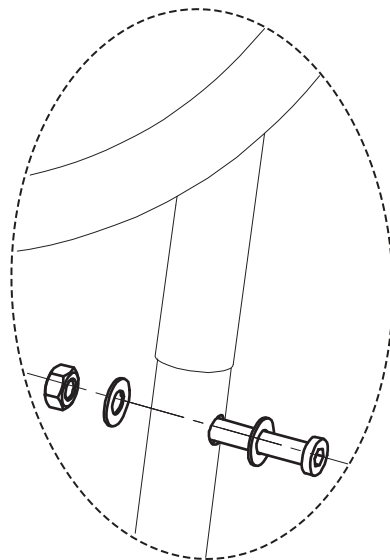
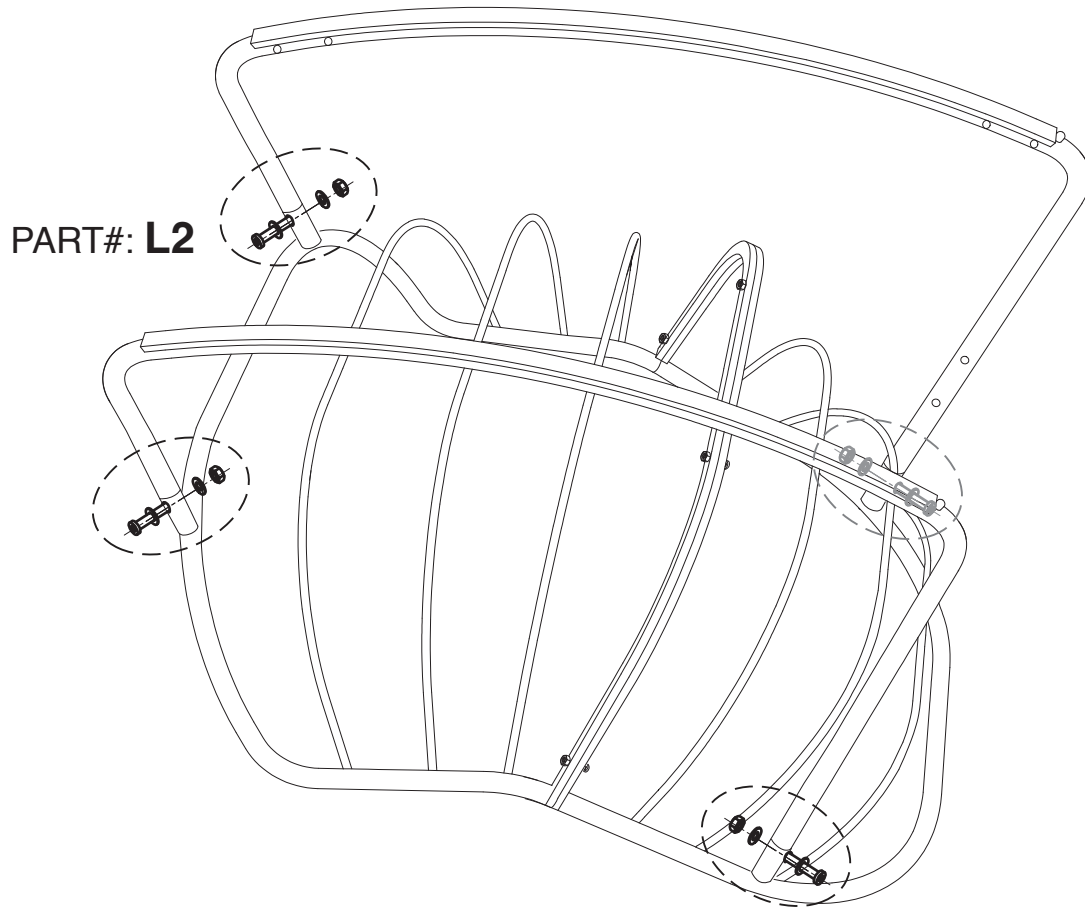

PART#: L2

ASSEMBLY

CHAIR ASSEMBLY (CONTINUED)

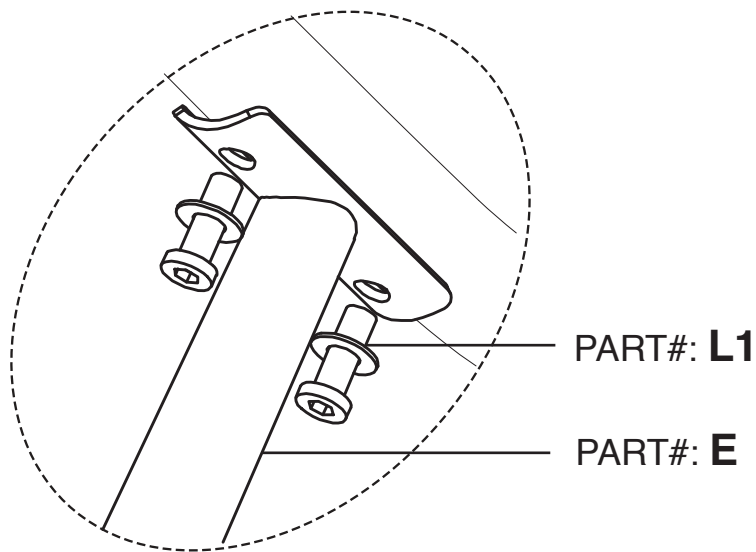
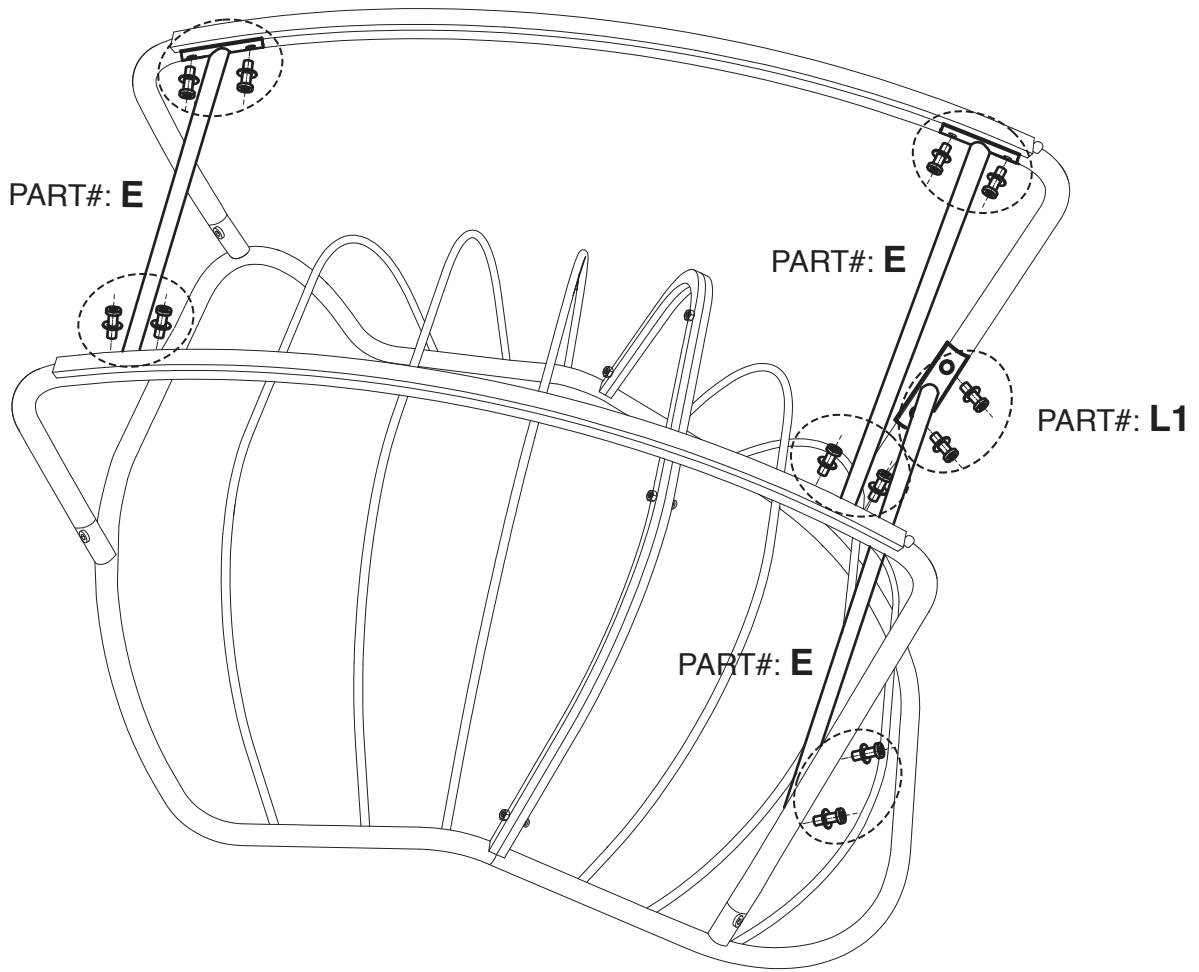

ASSEMBLY

CUSHION ASSEMBLY

PART#: **F**

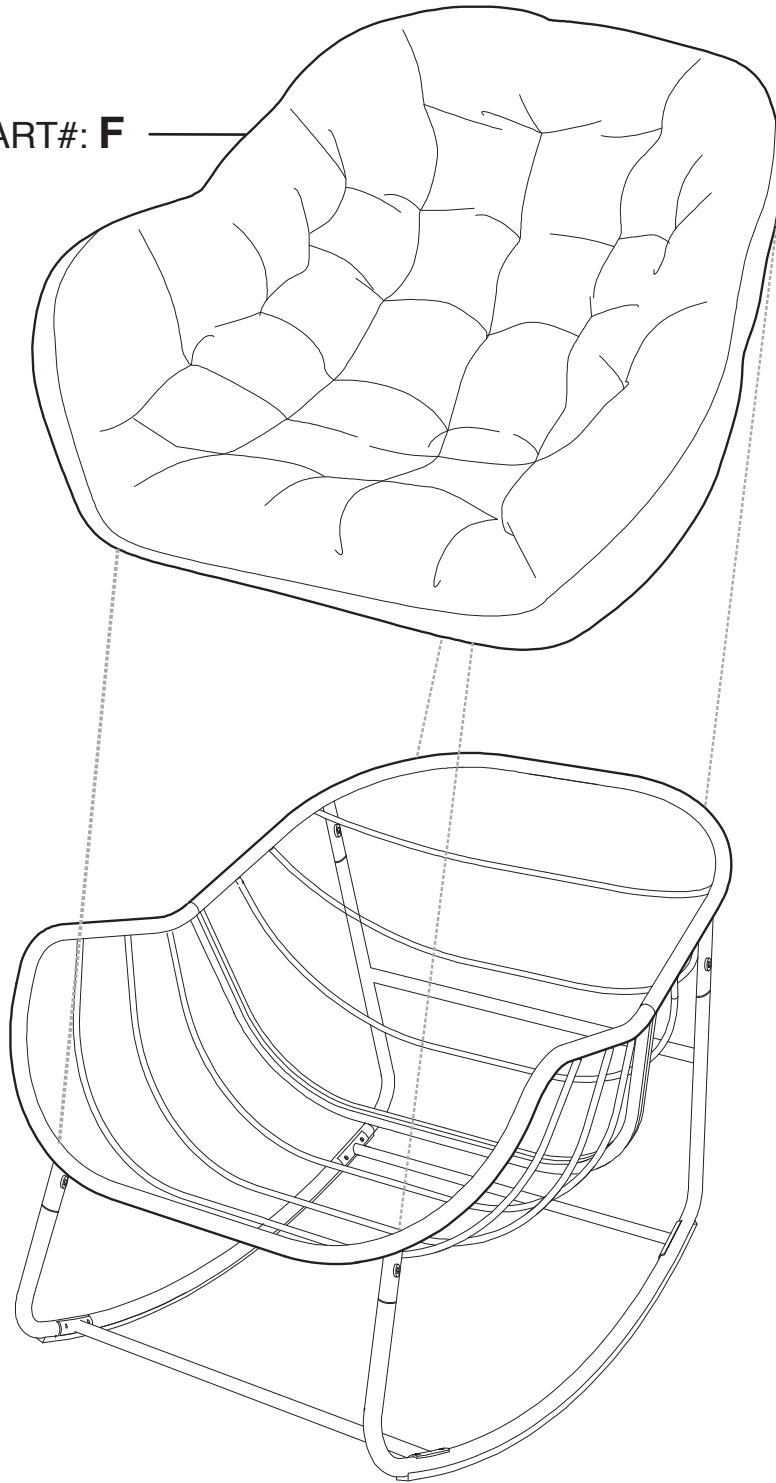

ASSEMBLY

COMPLETED



DISCLAIMER

DISCLAIMER

PLEASE READ THE FOLLOWING CAREFULLY

The manufacturer and/or distributor have provided the parts list and assembly diagram in this manual for reference purposes only. They do not make any representation or warranty to the buyer that they are qualified to make repairs to the product or replace any parts of the product. In fact, the manufacturer and/or distributor expressly state that all repairs and parts replacements should be undertaken by certified and licensed technicians, and not by the buyer.

The buyer assumes all risk and liability arising from their repairs to the original product or replacement parts or arising from their installation of replacement parts. It is strongly advised that qualified professionals handle any repairs or replacements to ensure safety and proper functioning of the product. Improper installation and operation may result in injury, property damage, or voiding of warranty. The manufacturer and/or distributor shall not be held responsible for any accidents, damages, or malfunctions resulting from the buyer's installation and operation of the product. It is essential to follow all safety guidelines and recommendations provided in this manual and to seek professional assistance if unsure about the installation or operation procedures.

CUSTOMER SERVICE

If you have any questions about ordering our pool pumps and replacement parts or pool products, please feel free to contact us using the following contact information:

Customer Service and Technical Support

Phone: (909) 628-0880

Email: customer@xtremepowerusa.com

Hours of Operation: Monday – Friday, 9AM – 4PM (CST)
